

125 kHz Proximity Physical Access “How to Order” Guide

D00530, Release B.1
April 21, 2010

The most current version of this document is always available for download at:
www.hidglobal.com/documents/125khz_htog_en.pdf.

To check status on your order, go to:
www.hidglobal.com > Knowledge Center > Customer Support > Customer Order Status.

For Contact cards, 3rd Party Contact-Chips and embeddable cards with or without contact chip, see the [Logical Access How to Order Guide](#).

For Embedded products, see the [Embedded How to Order Guide](#).

HID, HID Global, ProxCard, DuoProx, ProxKey, ISOProx, ProxPass, eProx, MicroProx, Flexpass, FlexKey, ProxPoint, MiniProx, ProxPro, ThinLine, MaxiProx, MultiProx, EntryProx, Prox80, FlexPass, and Corporate 1000 are the trademarks or registered trademarks of HID Global Corporation, or its licensors, in the U.S. and other countries.

This document is subject to change without notice.

Document History

Date	Author	Description	Version
04/21/10	BM, DD, LD	Removed embedded modules, updated Entry Prox	B.1
01/20/10	DD, WS	MCM 2 (Proximity Embedded Readers); FPISO, FPSMT, and FPMXI	B.0



Contents

Credentials 3

 Overview 3

 1326 - ProxCard® II Card Ordering Form 4

 1336 / 1536 - DuoProx® II Card Ordering Form 5

 1346 - ProxKey® II Keyfob Ordering Form 6

 1386 / 1586 - ISOProx® II Card Ordering Form 7

 1351 - ProxPass® II Vehicle Identification Tag Ordering Form 8

 1391 - MicroProx® Tag Proximity Ordering Form 9

 168/169 Style - ProxCard® Plus Card Ordering Form 10

 Direct Image PVC Glossy Label Part Numbers 11

 Custom Artwork Checklist Form 12

Indala 125kHz Credential 13

 FPISO - FlexPass Imageable Card Ordering Guide 14

 FPSMT - Flexpass™ Imageable Card with Contact Chip Ordering Guide 15

 FPCRD - FlexCard Standard Card Ordering Guide 16

 FPKEY - FlexKey® Keytag Ordering Guide 17

 CXKEY - CX Keytag Ordering Guide 18

 FPMXI - Flexpass™ Proximity Multiple Technology Imageable Card Ordering Guide 19

 FlexPass Formats 20

Electronic Artwork Requirement Checklist 21

Anti-Counterfeiting Descriptions 22

Custom Artwork Placement and Inkjet Location Form 23

 ProxCard® II Cards 23

 DuoProx® II Cards 24

 ISOProx® II Cards 25

 MicroProx Tag 26

1050AGN00 ProxProgrammer® Ordering Guide 27

HID Proximity Readers 28

 Accessories 28

 6005 / 6008 - ProxPoint® Plus Proximity Reader Part Numbers and Options 30

 5365 / 5368 - MiniProx® Proximity Reader Part Numbers and Options 31

 5455 / 5458 / 5355 / 5352 / 5358 - ProxPro® Family Proximity Reader Part Numbers and Options 32

 5395 / 5398 - ThinLine® II Proximity Reader Part Numbers and Options 33

 5375 - MaxiProx® Proximity Reader Part Numbers and Options 34

 5385 / 6000 / 6020 - MultiProx® Proximity Family Part Numbers and Options 35

 4045 - EntryProx™ Proximity Reader Part Numbers and Options 36

 5405 / 5408 - Prox80™ Proximity Reader Part Numbers and Options 37

Indala Proximity Readers 38

 Overview 38

 FP - FlexPass® Reader Ordering Guide 39

 Advantage Series (ASR) Reader Ordering Guide 40

 ProxSmith Programmer and Software Part Numbers 40

 FlexPass Accessories 41

Corporate 1000™ Format - Request & Authorization Form 42

Index of Terms for HID Credentials 44



Credentials

Overview

Each part number consists of a base number, to indicate the type of Credential, and a number or letter to indicate each Credential option. Each Credential has a standard part number which includes default options, as indicated on the attached Credential guides. When an order is placed for a credential, the base number and all options must be specified. If you require any options that are different from the default options, you must also indicate those options at the time the order is placed. All part numbers must be complete to be accepted by HID's order entry system.

All credential orders must have the following information:

- **Base Model Number** - Indicates type of credential
- **Frequency** - Indicates high (400 kHz), low (125 kHz), or (13.56 MHz) frequency. Low frequency (125 kHz) is standard for all HID Proximity access credentials. 400 kHz is an optional frequency offered for use with the older generation Destron/IDI products and ProxCard® II proximity credentials. 13.56 MHz is the contactless frequency associated with iCLASS® and MIFARE®.
- **Programming** - Indicates whether the credential is programmed at the factory by HID or programmed by you with an HID field programmer. If the credential is ordered non-programmed, an HID field programmer must be used for programming. (Contact an HID sales representative for field programmer eligibility.)

Note: For the iCLASS Prox embeddable card, see the [Logical Access How to Order Guide](#).

- **Front Packaging** - Indicates standard or custom artwork and type of finish.
- **Back Packaging** - Indicates standard or custom artwork and type of finish.
- **125 kHz Credential Numbering** - Internal 125 kHz programmed number and visible external credential number.
- **Slot Punch**

All orders for custom artwork credentials must have the following information:

- **Custom Artwork Number** (Call your Customer Service Representative if number is not available.)

In addition, all credential orders must have the following programming information:

- **Bit and Format(s) Numbers**
- **Facility Code(s)**
- **Internal and External Start Numbers**
- **Any Special Instructions**

All trademarks and registered trademarks are the properties of their respective companies.



1326 - ProxCARD® II Card Ordering Form

Please ensure each required option has been checked with the appropriate choice to fulfill a completed order form.

1326 Base Model

Programming (Check One)

- L - Programmed, Low Frequency (125 kHz) HID. Specify Programming Information.
- C - Programmed, Low Frequency (125 kHz) Casi Rusco⁴. (Identified on Ink jet Markings) Specify Programming Information.
- N - Non-Programmed, Low Frequency (125 kHz). Programming Information Not Required.

Front Packaging (Check One)

- S - ProxCARD II Artwork - Vinyl with Matte Finish
- M - Plain White Vinyl with Matte Finish
- G - Plain White PVC with Gloss Finish
- A - ProxCARD II with Adhesive Front¹
- C - Custom Artwork - Specify Custom Artwork Number²

Back Packaging (Check One)

- S - Base with Molded HID Logo
- C - Custom Artwork - Specify Custom Artwork Number²

Card Numbering³ (Check One)

- M - Sequential Matching Internal/External (Inkjetted)
- N - No External Card Numbering
- S - Sequential Internal/Sequential Non-Matching External (Inkjetted)
- R - Random Internal/Non-Matching Sequential External (Inkjetted)

Slot Punch

- V - Vertical Slot Punch

Option - Custom Artwork²

- _____ (Specify Artwork Number – Refer to the Custom Artwork Forms for new Artwork)

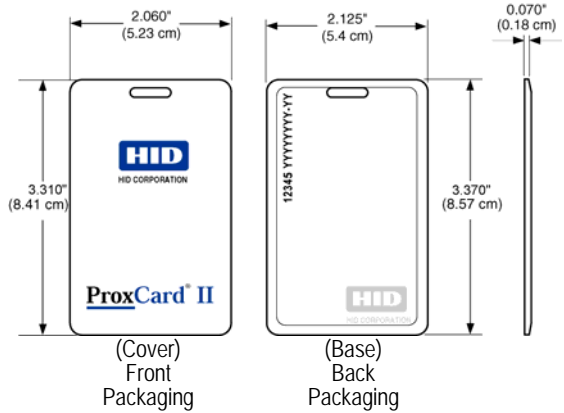

12345 = Card ID Number
 YYYYYYYY-YY = Sales Order Number

Please enter your final card options from check boxes above. Example: 1326LSSM^V

Final Part Number	1326				V	-	(Options #)
-------------------	------	--	--	--	---	---	-------------

125 kHz Card Programming Information

Bit Numbers _____ (example: 26 bit) Format Number _____ (example: H10301)

Facility Code _____

(Custom Formats) Site Code _____ City Code _____ OEM Code _____

Internal Card No. Start _____ Stop _____

External Card No. Start _____ Stop _____

Special Instructions: _____

¹ The part numbers for non-adhesive labels to be used with the ProxCARD II with the adhesive front are 1324GGN31 without slot and 1324GGV31 with slot.

² For new artwork files, contact Customer Service for custom artwork number, lead-times, and cost.

³ The external card number is placed in the top left-hand corner on the back of the card. HID logo molded into base on back.

⁴ Programmed as a sequential 12 digit number.



1336 / 1536 - DuoProx® II Card Ordering Form

Please ensure each required option has been checked with the appropriate choice to fulfill a completed order form.

Base Model	<input type="checkbox"/> 1336 Standard PVC	<input type="checkbox"/> 1536 Composite 40% Polyester / PVC *
-------------------	--	---

Programming (Check One)

- L - Programmed, Low Frequency (125 kHz). Specify Programming Information.
- C - Programmed, Low Frequency (125 kHz) Casi Rusco⁶. (Identified on Ink jet Markings) Specify Programming Information.
- N - Non-Programmed, Low Frequency (125 kHz). Programming Information Not Required.

Front Packaging (Check One)

- G - Plain White PVC w/ Gloss Finish
- C - Custom Artwork w/ Gloss Finish – Specify Custom Artwork Number¹

Back Packaging (Check One)

- G - Plain White PVC w/ Gloss Finish²
- S - Standard DuoProx II Artwork Gloss Finish²
- C - Custom Artwork w/ Gloss Finish – Specify Custom Artwork Number^{1,2}

Card Numbering³ (Check One)

- M - Sequential Matching Internal/External (Inkjetted)
- N - No External Card Numbering
- S - Sequential Internal/Sequential Non-Matching External (Inkjetted)
- R - Random Internal/Non-Matching Sequential External (Inkjetted)
- A - Sequential Matching Internal/External (Engraved)⁵
- B - Sequential Internal/Sequential Non-Matching External (Engraved)⁵
- C - Random Internal/Non-Matching Sequential External (Engraved)⁵

Slot Punch⁴ (Check One)

- N - No Slot Punch (*Printed location of vertical and horizontal slot punch will remain*)
- V - Vertical Slot Punch (*Printed location of horizontal slot punch will remain*)
- H - Horizontal Slot Punch (*Printed location of vertical slot punch will remain*)

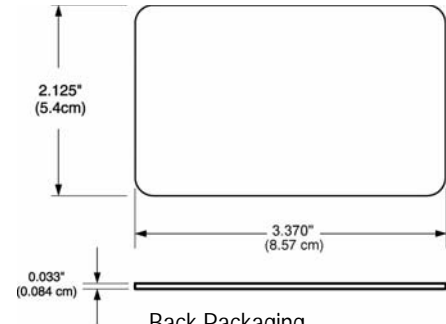

12345 = Card ID Number
 YYYYYYYY-YY = Sales Order Number

For the DuoProxII embeddable card, see the [Logical Access How to Order Guide](#).

Option - Custom Artwork¹

- _____ (Specify Artwork Number – Refer to the Custom Artwork Forms for new Artwork)

Please enter your final card options from check boxes above. Example: 1336LGGMN

Final Part Number											-	(Options #)
-------------------	--	--	--	--	--	--	--	--	--	--	---	-------------

125 kHz Card Programming Information

Bit Numbers _____ (example: 26 bit) Format Number _____ (example: H10301)

Facility Code _____

(Custom Formats) Site Code _____ City Code _____ OEM Code _____

Internal Card No. Start _____ Stop _____

External Card No. Start _____ Stop _____

Special Instructions: _____

¹ For new artwork files, contact Customer Service for custom artwork number, lead-times, and cost.
² Cards ordered with plain white front and back packaging, with no HID artwork or with custom artwork, will still have a small "HID logo" and reference number printed in the lower left-hand corner and a slot punch target printed on the back of the card.
³ The external card number is placed in the bottom right-hand corner on the back of the card.
⁴ Cards are provided with an optional slot punch at no additional charge. Some video imaging printers cannot accommodate pre-slot punched cards. Please consult with the printer manufacturer prior to ordering.
⁵ For Laser Engraved external numbers, consult factory for lead times and cost.
⁶ Programmed as a sequential 12 digit number.
 * The composite construction is recommended for all cards that will have an over-laminate applied.



1346 - ProxKey® II Keyfob Ordering Form

Please ensure each required option has been checked with the appropriate choice to fulfill a completed order form.

1346 Base Model

Programming (Check One)

- L - Programmed, Low Frequency (125 kHz). Specify Programming Information.
- N - Non-Programmed, Low Frequency (125 kHz). Programming Information Not Required.

Front Packaging

- S - Standard HID Logo

Back Packaging

- S - Standard

Keyfob Numbering¹ (Check One)

- M - Sequential Matching Internal/External (Inkjetted)
- O - Sequential External only (Inkjetted)
- N - No External Card Numbering
- S - Sequential Internal/Sequential Non-Matching External (Inkjetted)
- R - Random Internal/Non-Matching Sequential External (Inkjetted)
- A - Sequential Matching Internal/External (Engraved)²
- B - Sequential Internal/Sequential Non-Matching External (Engraved)²
- C - Random Internal/Non-Matching Sequential External (Engraved)²

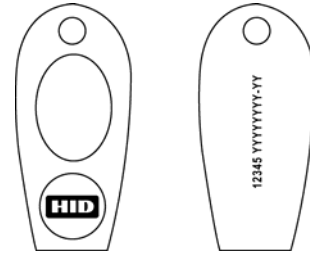

Front Packaging

Back Packaging

12345 = Keyfob ID Number YYYYYYYY-YY = Sales Order Number
--

Slot Punch³

- N - No Option

Please enter your final ProxKey options from check boxes above. Example: 1346LSSMN

Final Part Number	1346		S	S		N
-------------------	------	--	---	---	--	---

125 kHz ProxKey Programming Information

Bit Numbers _____ (example: 26 bit) Format Number _____ (example: H10301)

Facility Code _____

(Custom Formats) Site Code _____ City Code _____ OEM Code _____

Internal Key No. Start _____ Stop _____

External Key No. Start _____ Stop _____

Special Instructions: _____

¹ The external number is placed on the back of the Keyfob.
² For Laser Engraved external numbers, consult factory for lead times and cost.
³ Key Ring sold separately (Part Number: 57-0001-02).



1386 / 1586 - ISOProx® II Card Ordering Form

Please ensure each required option has been checked with the appropriate choice to fulfill a completed order form.

Base Model **1386 Standard PVC** **1586 Composite 40% Polyester / PVC ***

Programming (Check One)

- L - Programmed, Low Frequency (125 kHz). Specify Programming Information.
- C - Programmed, Low Frequency (125 kHz) Casi Rusco⁶. (Identified on Ink jet Markings) Specify Programming Information.
- N - Non-Programmed, Low Frequency (125 kHz). Programming Information Not Required.

Front Packaging (Check One)

- G - Plain White PVC w/ Gloss Finish
- C - Custom Artwork w/ Gloss Finish – Specify Custom Artwork Number¹

Back Packaging (Check One)

- G - Plain White PVC w/ Gloss Finish²
- S - Standard ISOProx II Artwork Gloss Finish²
- C - Custom Artwork w/ Gloss Finish – Specify Custom Artwork Number^{1, 2}

Card Numbering (Check One)

- M - Sequential Matching Internal/External (Inkjetted)
- N - No External Card Numbering
- S - Sequential Internal/Sequential Non-Matching External (Inkjetted)
- R - Random Internal/Non-Matching Sequential External (Inkjetted)
- A - Sequential Matching Internal/External (Engraved)⁵
- B - Sequential Internal/Sequential Non-Matching External (Engraved)⁵
- C - Random Internal/Non-Matching Sequential External (Engraved)⁵

Slot Punch⁴ (Check One)

- N - No Slot Punch (*Printed location of vertical and horizontal slot punch will remain*)
- V - Vertical Slot Punch (*Printed location of horizontal slot punch will remain*)
- H - Horizontal Slot Punch (*Printed location of vertical slot punch will remain*)

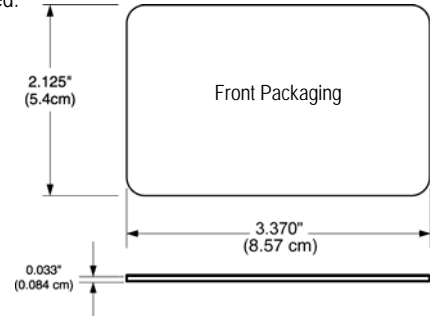

12345 = Card ID Number
YYYYYYYY-YY = Sales Order Number

For the IsoProx II embeddable card, see the [Logical Access How to Order Guide](#).

Option - Custom Artwork¹

_____ (*Specify Artwork Number – Refer to the Custom Artwork Forms for new Artwork*)

Please enter your final card options from check boxes above. Example: 1386LGGMN

Final Part Number		-	<i>(Options #)</i>
--------------------------	--	---	--------------------

125 kHz Card Programming Information

Bit Numbers _____ (*example: 26 bit*) Format Number _____ (*example: H10301*)
 Facility Code _____
 (Custom Formats) Site Code _____ City Code _____ OEM Code _____
 Internal Card No. Start _____ Stop _____
 External Card No. Start _____ Stop _____
 Special Instructions: _____

¹ For new artwork files, contact Customer Service for custom artwork number, lead-times, and cost.
² Cards ordered with plain white front and back packaging, with no HID artwork or with custom artwork, will still have a small "HID logo" and reference number printed in the lower left-hand corner and a slot punch target printed on the back of the card.
³ The external card number is placed in the bottom right-hand corner on the back of the card.
⁴ Cards are provided with an optional slot punch at no additional charge. Some video imaging printers cannot accommodate pre-slot punched cards. Please consult with the printer manufacturer prior to ordering.
⁵ For Laser Engraved external numbers, consult factory for lead times and cost.
⁶ Programmed as a sequential 12 digit number.
 * The composite construction is recommended for all cards that will have an over-laminate applied.



1351 - ProxPass® II Vehicle Identification Tag Ordering Form

Please ensure each required option has been checked with the appropriate choice to fulfill a completed order form.

1351 Base Model

Programming

L - Programmed, Low Frequency (125 kHz). Specify Programming Information.

Color

B - Standard beige finish

Back Packaging

S - Standard HID logo

Tag Numbering (Check One)

- M - Sequential Matching Internal/External (Inkjetted)
- N - No External Card Numbering
- S - Sequential Internal/Sequential Non-Matching External (Inkjetted)
- R - Random Internal/Non-Matching Sequential External (Inkjetted)

Hardware Option

N - None

Please enter your final Tag options from check boxes above. Example: 1351LBSMN

Final Part Number	1351	L	B	S		N	-	(Optional Artwork #)
-------------------	------	---	---	---	--	---	---	----------------------

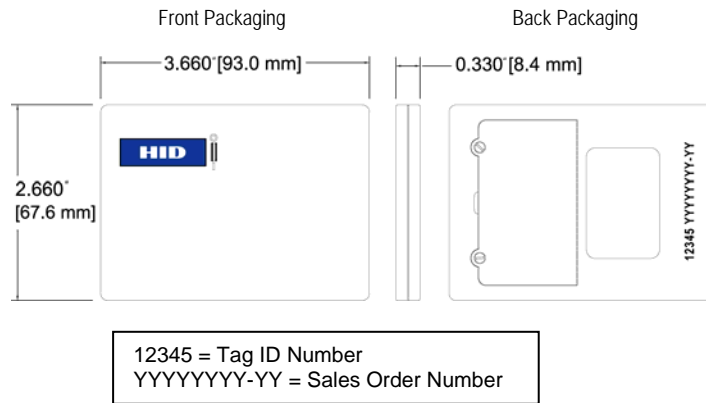

125 kHz Tag Programming Information

Bit Numbers _____ (example: 26 bit) Format Number _____ (example: H10301)

Facility Code _____

(Custom Formats) Site Code _____ City Code _____ OEM Code _____

Internal Tag No. Start _____ Stop _____

External Tag No. Start _____ Stop _____

Special Instructions: _____

The ProxPass II Tag includes two replaceable internal batteries and Velcro strips for a complete and simple installation. Battery Part # BR2330, available at most electronic stores (not sold by HID).



1391 - MicroProx® Tag Proximity Ordering Form

Please ensure each required option has been checked with the appropriate choice to fulfill a completed order form.

1391 Base Model

Programming (Check One)

- L - Programmed, Low Frequency (125 kHz). Specify Programming Information.
- C - Programmed, Low Frequency (125 kHz) Casi Rusco⁶. (Identified on Ink jet Markings) Specify Programming Information.
- N - Non-Programmed, Low Frequency (125 kHz). Programming Information Not Required.

Front Packaging (Check One)

- S - Gray with HID Standard Artwork
- K - Black with HID Standard Artwork
- B - Plain Black Finish, (No Artwork)
- G - Plain Gray Finish, (No Artwork)
- C - Custom Artwork – Specify Custom Artwork Number¹

Back Packaging³

- S - Adhesive Backing

Tag Numbering² (Check One)

- M - Sequential Matching Internal/External (Inkjetted)
- O - Sequential External only (Inkjetted)
- N - No External Tag Numbering
- S - Sequential Internal/Sequential Non-Matching External (Inkjetted)
- R - Random Internal/Non-Matching Sequential External (Inkjetted)

Slot Punch

- N - None

Optional Custom Artwork¹

_____ (Specify Artwork Number – Refer to the Custom Artwork Forms for new Artwork)

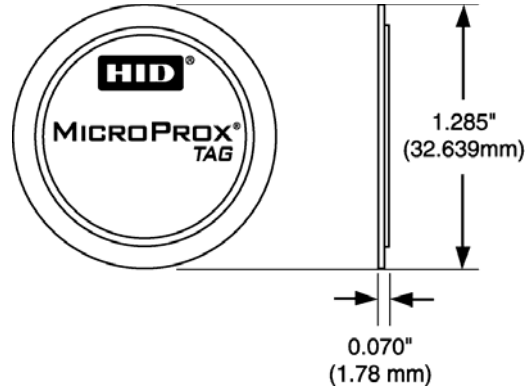

Please enter your final Tag options from check boxes above. Example: 1391LKSMN

Final Part Number	1391			S		N	-	(Optional Artwork #)
-------------------	------	--	--	---	--	---	---	----------------------

125 kHz Tag Programming Information

Bit Numbers _____ (example: 26 bit) Format Number _____ (example: H10301)

Facility Code _____

(Custom Formats) Site Code _____ City Code _____ OEM Code _____

Internal Tag No. Start _____ Stop _____

External Tag No. Start _____ Stop _____

Special Instructions: _____

¹ For new artwork files, contact Customer Service for custom artwork number, lead-times, minimum order quantities, and cost.

² The external tag number is placed on the back of the tag.

³ The MicroProx Tag is not for use on cards that use full insertion or tractor feed type readers.

Do not adhere to metal surfaces. Metal shields the RF, making the tag inoperable. Due to variations in cards and reading devices, HID does not claim that the MicroProx Tag will work in every situation. Functional and non-functional MicroProx Tags are available for compatibility testing with existing credential and reader technologies. Compatibility should be confirmed prior to ordering.

MicroProx Placement

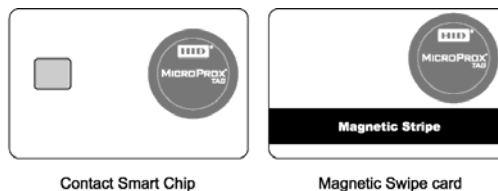



168/169 Style - ProxCard® Plus Card Ordering Form

Instructions

1. Select one option from each category (1-5) and mark the appropriate box.
2. Complete the Programming Information and Company Information Sections.
3. Fax the completed Ordering Guide to HID's North Haven, CT, office at 1-203-407-5967, Attn.: Customer Service.
4. HID Corporation will determine the correct part number based on the options you specify, and fax you the part number and specification sheet.
5. Place an order for the ProxCard Plus card with the part number provided by HID.

Card Thickness: 0.047" ± 0.004" - Check with your printer manufacturer to verify card printability
 - Magnetic Stripe applications: Verify reader slot width.

Style 168 card = Non-printable surface, Matte Finish

Style 169 card = Printable surface, Gloss Finish

1. Card Front

5. Slot Punch³

- ProxCard Plus Artwork
- Plain White¹
- Custom Artwork (500 Min.)

- No Slot Punch (Printed halo of horizontal slot punch will remain)
- Horizontal Slot Punch⁴

2. Card Back

6. Card Style (Wiegand Code Strip Location)

- Plain White
- Custom Artwork (500 Min.)

- A (If unsure, or card is to be used in a mixed reader environment, please contact the factory)
- A1

3. Card Finish

- Matte Finish
- Gloss Finish

Notes:
 Please call customer service for availability, minimum order requirements, and a quote for custom cards.

NOTE: Cards are manufactured with similar front and back side finishes only, (i.e. Matte/Matte or Gloss/Gloss)

¹ Cards ordered with plain white front and back packaging, with no HID artwork or custom artwork, will have a small "HID" printed in the lower right-hand corner and a horizontal slot punch halo target printed on the back of the card.

4. High Coercivity Magnetic Stripe

- Front
- Back
- None

² The external card number is ink jet printed in the lower left-hand corner on the back of the card. Zero gap numbering is not available. The external PIN numbers will be associated with the Wiegand programming unless otherwise specified.

³ Some video imaging printers cannot accommodate pre-slot punched cards. Please consult with the printer manufacturer prior to printing.

⁴ Consult customer service for vertical slot punch.

Programming Information (Wiegand):

Programming Information (Proximity):
(If different than Wiegand Programming Info)

Company Information:

Facility Code: "A" Field _____
 "B" Field _____
 (if required)

Facility Code: "A" Field _____
 "B" Field _____
 (if required)

Company Name: _____

Bit Format: _____

Contact: _____

Internal PIN Start No: _____

Bit Format: _____

Address: _____

External Card Numbering²: _____

Internal PIN Start No: _____

City: _____

- Front
- Back

Total Qty.: _____ (100 Min.)

State: _____

- Matching PIN

Zip Code: _____

- Non-Matching Sequential Start No.:

Phone: _____

- Non-Matching Start No. (Random):

Fax: _____

- None

For Internal Use Only (To be Completed by HID):

ProxCard Plus Part Number:

Part No.: 1 6 8 _____ or 1 6 9 _____

Issued By: _____ Date: _____

**Direct Image PVC Glossy Label Part Numbers**

Part #	Description	Thickness	Dimensions
1324GAV11	ProxCard II size with slot punch, white adhesive back	10 mil PVC	3.310" x 2.060"
1324GAN11	ProxCard II size, no slot punch, white adhesive back	10 mil PVC	3.310" x 2.060"
1324GAV21	ProxCard II size with slot punch, white adhesive back	20 mil PVC	3.310" x 2.060"
1324GAN21	ProxCard II size, no slot punch, white adhesive back	20 mil PVC	3.310" x 2.060"
1324GGV31	ProxCard II size with slot punch, no adhesive	30 mil PVC	3.310" x 2.060"
1324GGN31	ProxCard II size, no slot punch, no adhesive	30 mil PVC	3.310" x 2.060"
1324GBV22	ISOProx II and ProxCard II size with slot punch, brown (3M) adhesive back	20 mil PVC	3.370" x 2.125"
1324GBN22	ISOProx II and ProxCard II size, no slot punch, brown (3M) adhesive back	20 mil PVC	3.370" x 2.125"
1324GAV22	ISOProx II and ProxCard II size, with slot punch, white adhesive back	20 mil PVC	3.370" x 2.125"
1324GAN22	ISOProx II and ProxCard II size, no slot punch, white adhesive back	20 mil PVC	3.370" x 2.125"
1324CAN10	Clear guard protection label for use with all direct image cards		

1. Some dye sublimation printers cannot accommodate pre-slot punched labels; please consult with the printer manufacturer prior to ordering.
2. Labels are packaged in multiples of 100 pieces. Minimum order quantity is 100 pieces. Orders will be accepted in multiples of 100 pieces per label Model.
3. Please make sure to adjust your dye sublimation printer setting to the proper PVC label thickness and dimension.



Custom Artwork Checklist Form

Company Name:		PO No.		Date	
Quantity:		Card/Tag and Artwork File No.			

Minimum order quantity for Custom Artwork is 500 cards per order. Some Custom Artworks may be higher.



This form, accompanied with the "Custom Artwork placement and Inkjet Location Form" MUST be filled out, SIGNED and returned to HID so that your order can be processed.

Card Type: Standard PVC

1326 - ProxCard® II
 1386 - ISOProx® II
 1336 - DuoProx® II
 1391 - MicroProx Tag

Card Type: Composite PVC/Polyester (Additional fee and longer lead-time)

1586 - ISOProx® II
 1536 - DuoProx® II

Artwork Placement, Font styles and Colors:

Artwork Placement on **Front Side** of card
 Artwork Placement on **Back Side** of card
 Font Style(s): _____
 Front Side Color(s): _____
 Back Side Color(s): _____

Do you plan to print over or around the custom artwork with a dye sublimation printer? Yes No

"Surface" or "Laminated" Lithographic Printing (Refer to the "Anti-Counterfeiting Descriptions" page in this guide for details)

Card Options:

Slot Punch^{1,4}: Yes No
 Horizontal Vertical
 Signature Panel: Yes No
 Size: _____
 Front Card Finish: Gloss
 Back Card Finish: Gloss
 Magnetic Stripe Coercivity: HID Standard (4000 OE)
 (2750 OE)
 Magnetic Stripe Type: Standard 3 Track
 Debitek 1/8"
 Other: _____

Anti-Counterfeiting Options:

Invisible Ink: Red Yellow Blue Green Glow in the Dark
 Microfine Print: Yes No
 Hologram⁶: Surface Embedded

Notes:

- ProxCard II card is only available with a vertical slot punch. Some cards will have printed "indicators" on the back of the card to show both the vertical and horizontal slot punch locations.
- Magnetic Stripe available for DuoProx II, Smart DuoProx II.
- Some cards will have a small "HID logo" and reference number, custom artwork file number, and external number (optional) printed on the card.
- Do not order slot punched cards for use in dye sublimation printers. Slot edge may damage the printer ribbon. Slot should be punched after dye sublimation printing.
- Some video imaging printers cannot accommodate pre-slot punched cards. Please consult with the printer manufacturer prior to ordering.
- Surface Holograms cannot be placed over internal electronics.
- Representation, Warranty and Indemnity. Customer represents and warrants to HID that it owns, controls, or otherwise has the full and unrestricted right to use the custom artwork provided to HID for use in connection with this Custom Artwork Checklist Form (the "Custom Artwork") and to authorize and license HID to use and apply the Custom Artwork to the cards in the manner provided in this Custom Artwork Checklist Form. Customer agrees to indemnify HID and hold it harmless from and against any claims, liabilities, losses and/or expenses (including reasonable attorney fees and costs of suit) arising out of the use by HID of the Custom Artwork in the manner provided by this Custom Artwork Checklist Form or by any custom artwork proofs approved by the Customer."
- HID does not recommend placing custom graphics on either side of the Contact Smart Chip area.
- Halftones not recommended for ProxCard II cards.

Name: _____ Signature: _____ Date: _____



Indala 125kHz Credential

Every part number consists of a base model number to indicate the type of product, and a letter or number to indicate each product option. Each Indala[®] product has a standard part number that includes default options, as indicated on the order guide. When an order is placed for a product, the base model number and all options must be specified. If you require any options that are different from the default options, you must also indicate those options at the time the order is placed. All part numbers must be complete to be accepted by HID's order entry system.

All card orders must have the following information:

- **BASE MODEL NUMBER** – Specifies card or type
- **PROGRAMMING** – Specifies if card is factory or field programmed (*format or format number, facility code, and ID number range must be given at time of order*)
- **FRONT or FLAT SIDE GRAPHICS** – Specifies standard or custom artwork, and smart chip placement
- **BACK or EMBOSSED SIDE GRAPHICS** – Specifies standard or custom artwork, and smart chip placement
- **MARKING POSITION** – Specifies location of card marking.

Note: Card marking is surface printed and, therefore is not to be considered permanent. In certain cases Laser etching may be used instead of inkjet marking. Laser etching is permanent marking but is not used on all products.

- **SLOT PUNCH** – Specifies slot location if available
- **CARD OPTIONS** – Applies to FlexCard[®] (Base Model FPCRD/CXCRD) only
- **MAGNETIC STRIPE OPTION** – Specifies if card is to have a magstripe and which type (ISO Imageable Cards only)
- **CUSTOM FILE NUMBER** – Specifies the artwork number to be used



FPISO - FlexPass Imageable Card Ordering Guide

Standard Part No.: FPISO-SSSCNA-0000

Description: 125 kHz, white glossy finish front, white glossy finish with Indala logo back, marking on standard location, no slot punch, no magstripe, no artwork

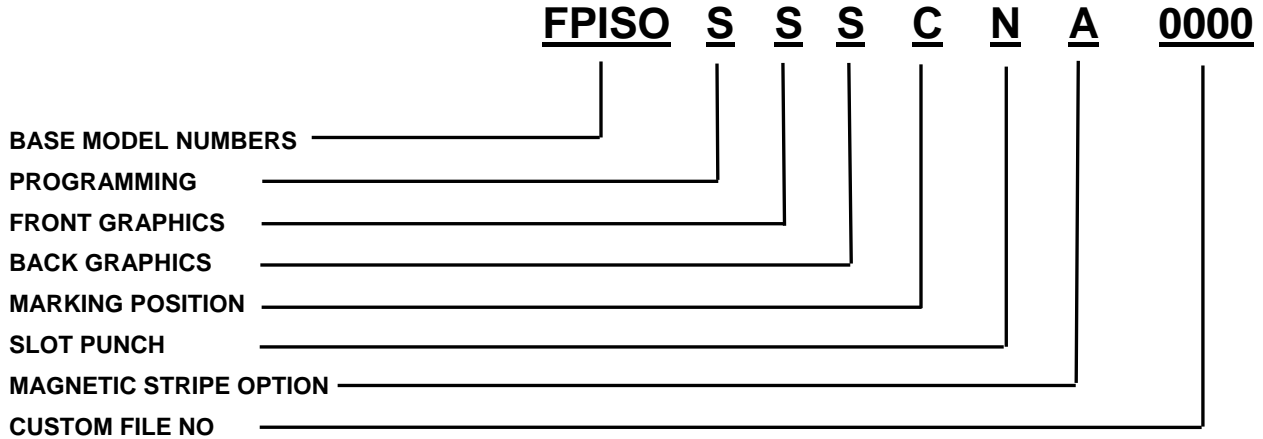

BASE MODEL NUMBERS

- FPISO** FlexISO® Proximity Card
- FPWGD** FlexISO Proximity and Wiegand Combination Card
- FPIXT** FlexISO XT Composite Proximity Card

(See “Multiple Technology Combination Cards and Tags” Section for additional choices)

PROGRAMMING

- S** = Standard, Programmed, Low Frequency 125 kHz – exact coding standard, with no gaps or over-runs
(Please specify Format Number, Facility Code, and ID Range)
- N** = Not Programmed, Low Frequency 125 kHz (Blank/Programmable)

FRONT GRAPHICS

- S** = Standard white glossy finish, suitable for video imaging
- C** = Custom (Artwork on file or new)

BACK GRAPHICS

- S** = Standard white glossy finish with Indala logo, card marking (Sales Order & matching internal ID number), suitable for dye sublimation imaging in most areas
- C** = Custom (Artwork on file or new)

MARKING POSITION

(Standard Marking is Label Code E153, which is Sales Order number & matching 5 digit internal ID number, is used unless otherwise specified)

- C** = Position 3/Standard Location (Back Side/Lower Right Corner)

Note: Inkjet marking is surface printed and, therefore is not to be considered permanent.

In some cases Laser etching will replace inkjet marking. Laser etching is permanent in most applications.

SLOT PUNCH

- N** = None
- V** = Vertical (portrait orientation)
- H** = Horizontal (landscape orientation)

MAGNETIC STRIPE OPTION

- A** = No Magstripe
- B** = Standard Magstripe (3-track, high coercivity, 4000 oersted)

Other Magstripe options are available as special orders.

Please call Customer Service for special order minimums and lead times)

CUSTOM FILE NUMBER (4 Characters – Factory Assigned)

0000 = No Artwork

(Call your Customer Service Representative for new artwork)

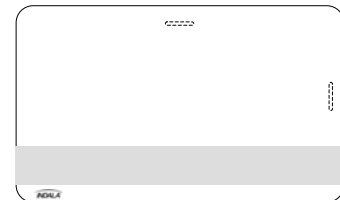



FPSMT - Flexpass™ Imageable Card with Contact Chip Ordering Guide

Sample Part No.: FPSMT-SSSCNAA-0000

Description: Flexpass™ Flex ISO Proximity, Prox programmed, white glossy finish front, white glossy finish with Indala logo back, marking on standard location, no slot punch, no magstripe, Contact Chip A, no artwork.

FPSMT - S S S C N A A - 0000

BASE MODEL NUMBERS

PROGRAMMING

FRONT GRAPHICS

BACK GRAPHICS

MARKING POSITION

SLOT PUNCH

MAGNETIC STRIPE OPTION

CONTACT CHIP

CUSTOM FILE NO.

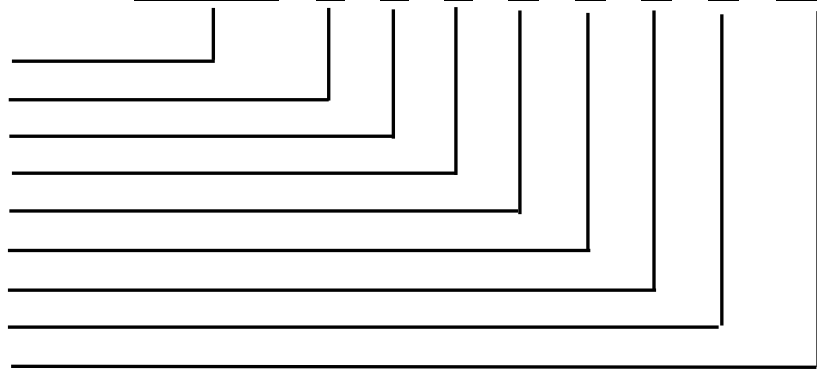

BASE MODEL NUMBERS

- FPSMT** 125 kHz FlexISO Proximity Card with Contact Chip
- CXSMT** 125 kHz CASI-RUSCO Compatible Proximity Card with Contact Chip
- FXSMT** 125 kHz FlexISO XT Proximity Card with Contact Chip

PROGRAMMING

- S = Standard, Flexpass Proximity programmed. (Please specify Format Number, Facility Code and ID Range)
- N = Not Programmed (Proximity blank/programmable).
- M = (CX Cards Only) Sequential Matching. Programmed, 125 kHz – CASI-RUSCO 12-digit format with matching (6-digit) external marked number. **Note:** inkjet matches last six digits of internal ID number, along with the CX designation and a date code. **CXddy 123456.** A cross reference of marking to encoded number will be provided with the order in .txt (text) format.
- Q = (CX Cards Only) Sequential Non Matching. Programmed, 125 kHz – CASI-RUSCO 12-digit format with a sequential non-matching 6-digit external marked number with a customer specified start number, along with the CX designation and a date code. **CXddy 123456.** A cross reference of marking to encoded number will be provided with the order in .txt (text) format.

FRONT GRAPHICS

- S = Standard white glossy finish, suitable for video imaging
- C = Custom (Artwork on file or new)

BACK GRAPHICS

- S = Standard white glossy finish with Indala logo, marking (Sales Order Number), suitable for dye sublimation imaging in most areas
- C = Custom (Artwork on file or new)

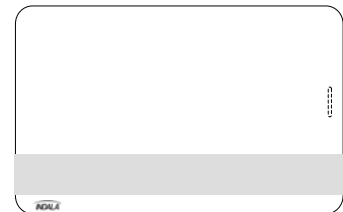

MARKING POSITION

- (Standard Marking or Label Code E153, which is Sales Order and ID number, is used unless otherwise specified) **Note:** Card marking is surface printed and, therefore is not to be considered permanent. In some cases Laser etching will replace inkjet marking. Laser etching is permanent in most applications.
- C = Position 3/Standard Location (Back Side/Lower Right Corner)

SLOT PUNCH

- N = None
- V = Vertical (portrait orientation)

MAGNETIC STRIPE OPTION

- A = No Magstripe
- B = Standard Magstripe (3-track, high coercivity, 4000 oersted)

CONTACT CHIP

Contact chip will be embedded on the front of the card.
 Due to constant changes in Contact Chip availability, please call Customer Service to help define the chip and card part number, and for lead times.
Note: There are minimum quantities required when ordering Contact Chips

CUSTOM FILE NO. (4 Characters – Factory Assigned)

- 0000** = No Artwork
(Call your Customer Service Representative for new artwork)



FPCRD - FlexCard Standard Card Ordering Guide

Standard Part No.: FPCRD-SSSMW-0000

Description: 125 kHz, printed Indala logo on front, embossed Indala logo on back, card marking on flat side (lower right corner with slot to the right), white color (not printable), no artwork. Vertical slot punch only.

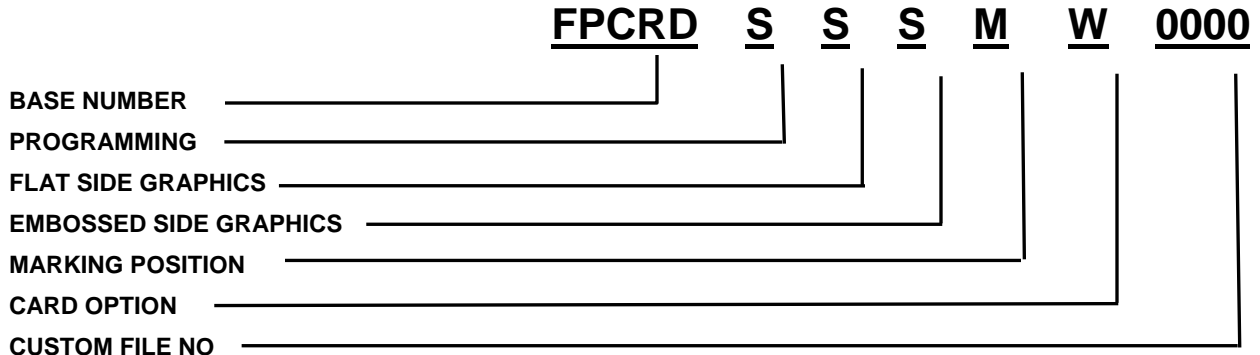

BASE NUMBER:

FPCRD – 125 kHz Clamshell type Proximity Card

PROGRAMMING

- S** = Standard, Programmed, Low Frequency 125 kHz – exact coding standard, with no gaps or over-runs
(Please specify Format or Format Number, Facility Code, and ID Range)
- N** = Not Programmed, Low Frequency 125 kHz (Blank/Programmable)

FLAT SIDE GRAPHICS

- S** = Standard (Flat Side with printed Indala logo)
- C** = Custom (Artwork on file or new)

EMBOSSSED SIDE GRAPHICS

- S** = Standard (Embossed Side with embossed Indala logo)
- C** = Custom (Artwork on file or new, still with embossed Indala logo)

MARKING POSITION

(Standard Marking or Label Code E153, which is Sales Order number & matching internal ID number, is used unless otherwise specified.)

Note: Inkjet marking is surface printed and, therefore is not to be considered permanent. In some cases Laser etching will replace inkjet marking. Laser etching is permanent in most applications.

- A** = Position 1/Flat Side (with slot punch to the right, lower left corner) – available with Printable Option only
- C** = Position 3/Flat Side (with slot punch to the right, lower right corner) – available with Printable Option only
- K** = Position 1/Embossed Side (with slot punch to the right, lower left corner)
- M** = (Standard) = Position 3/Embossed Side (with slot punch to the right, lower right corner)

CARD OPTION

- W** = White (standard color) - surface treated with UV protection – may not accept printing
- P** = Printable, matt finish – No varnish, no logo, surface will accept post printing

CUSTOM FILE NUMBER (4 Characters – Factory Assigned)

0000 = No Artwork
(Call your Customer Service Representative for new artwork)

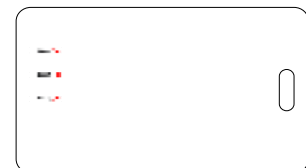
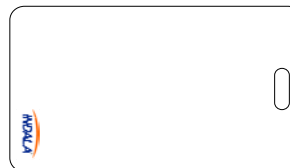

FPKEY - FlexKey® Keytag Ordering Guide

Standard Part No.: FPKEY-SSSS-0000

Description: 125 kHz, printed Indala logo on front side, printed strip for marking on back side

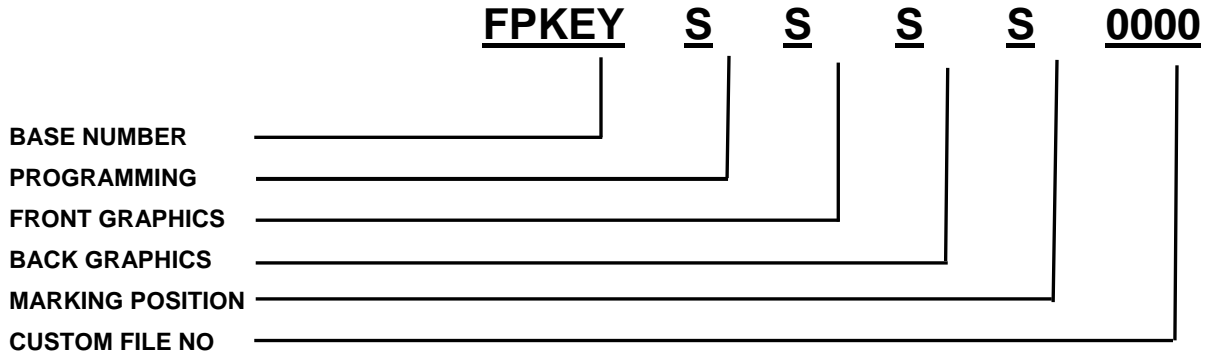

BASE NUMBER

FPKEY - 125 kHz Keytag Type Proximity Card

PROGRAMMING

S = Standard, Programmed, Low Frequency 125 kHz – exact coding standard, with no gaps or over-runs

(Please specify Format or Format Number, Facility Code, and ID Range)

N = Not Programmed, Low Frequency 125 kHz (Blank/Programmable)

FRONT GRAPHICS

S = Standard (printed Indala logo)

C = Custom (Artwork on file or new)

BACK GRAPHICS

S = Standard (no logo, printed strip for marking)

C = Custom (Artwork on file or new)

MARKING POSITION

(Standard Marking or Label Code E201, which is a shortened version of the Sales Order number & matching internal ID number, is used unless otherwise specified)

Note: Inkjet marking is surface printed and, therefore is not to be considered permanent. Most Keytag marking will be with Laser etching which is permanent in most applications.

S = Standard (back side on printed strip)

CUSTOM FILE NUMBER (4 Characters – Factory Assigned)

0000 = No Artwork

(Call your Customer Service Representative for new artwork)

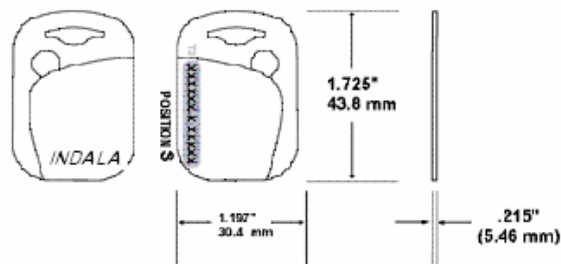



CXKEY - CX Keytag Ordering Guide

Standard Part No.: CXKEY-SSSS-0000
Description: 125 kHz, printed Indala logo on front side, printed strip for marking on back side.

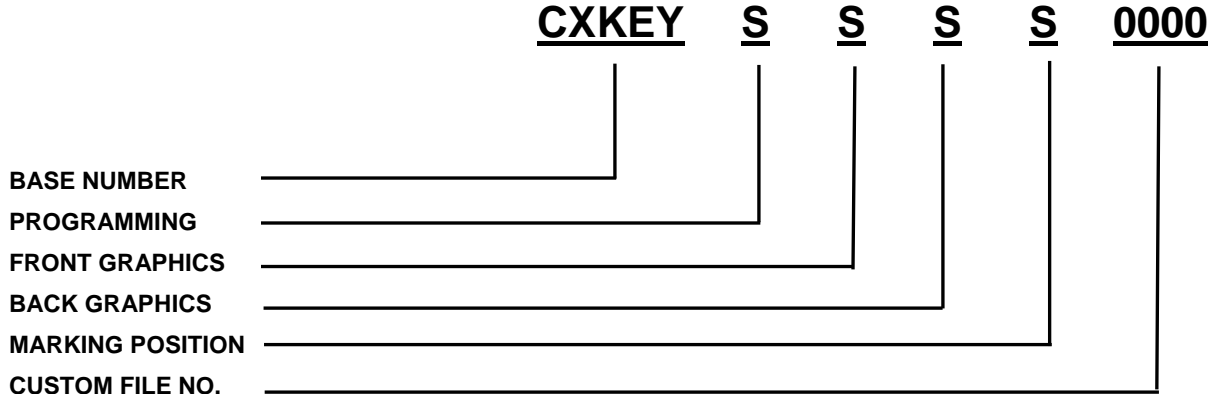

BASE NUMBER
CXKEY Keytag style proximity card

PROGRAMMING
S = Standard Programmed, Low Frequency 125 kHz – **CASI-RUSCO** 12-digit format with no external marking number. Marking of “CXddy” is standard.
M = Sequential Matching. Programmed, Low Frequency 125 kHz – **CASI-RUSCO** 12-digit format with matching (6-digit) external marked number. **Note:** the programmed internal number of a CASI card is a 12-digit ID number, example 151234123456. When Matching external numbers are requested, only the last six digits of the 12-digit encoded number are printed on the card along with the CX designation and a date code. For the sample number shown, the marking would be “CXddy 123456” A cross reference of marking to encoded number will be provided with the order in .txt (text) format
Q = Sequential Non Matching. Programmed, Low Frequency 125 kHz – **CASI-RUSCO** 12-digit format with a sequential 6-digit external marked number with a customer specified start number. (For example, if 2000 cards are ordered with a starting marking number of 425000, the marking would start at “CXddy 425000” and end at “CXddy 426999”) A cross reference of marking to encoded number will be provided with the order in .txt (text) format.

FRONT GRAPHICS
S = Standard (printed Indala logo)
C = Custom (Artwork on file or new)

BACK GRAPHICS
S = Standard (no logo, printed strip for marking)
C = Custom (Artwork on file or new)



MARKING POSITION
 (Standard Marking (the CX designation and a date code), is used unless otherwise specified)
Note: Inkjet marking is surface printed and, therefore is not to be considered permanent.
 Most Keytag marking will be with Laser etching which is permanent in most applications.
S = Standard (back side on printed strip)

CUSTOM FILE NUMBER (4 Characters – Factory Assigned)
0000 = No Artwork
 (Call your Customer Service Representative for new artwork)



FPMXI - Flexpass™ Proximity Multiple Technology Imageable Card Ordering Guide

Sample Part No.: FPMXI-SSSCNAA-0000

Description: Flexpass™ Proximity with MIFARE 1K card, Prox programmed, MIFARE blank, white glossy finish front, white glossy finish with Indala logo back, marking on standard location, no slot punch, no magstripe, no artwork.

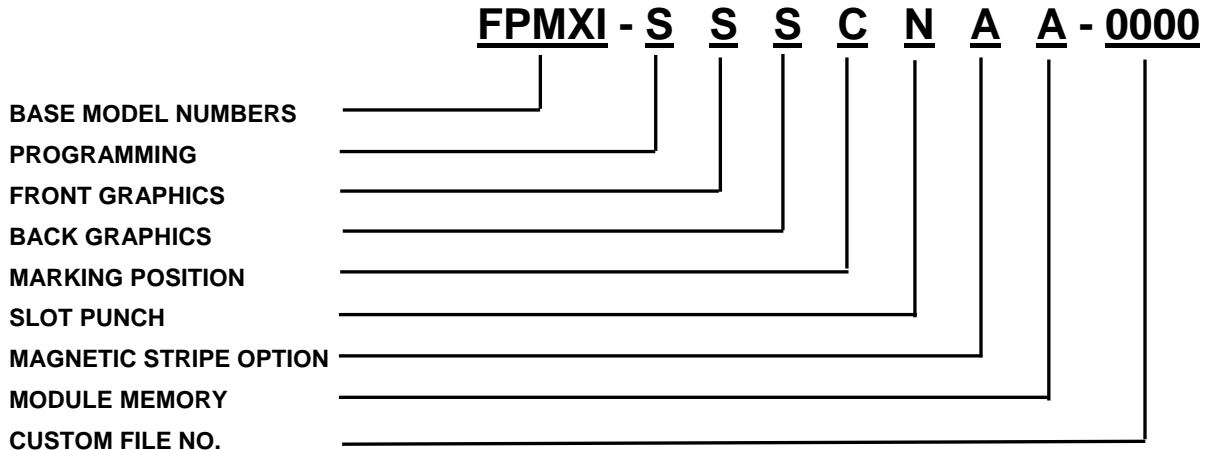

BASE MODEL NUMBERS

- FPMXI** 125 kHz Flexpass Proximity /13.56 MHz MIFARE Combination Card
- CXMXI** 125 kHz CASI-RUSCO Compatible Proximity /13.56 MHz MIFARE Combination Card
- CXMXI** 125 kHz CASI-RUSCO Compatible Proximity /13.56 MHz MIFARE Combination Card
- CXDXI** 125 kHz CASI-RUSCO Proximity Compatible/13.56 MHz DESFire Combination Card

PROGRAMMING

- S** = Standard, Flexpass Proximity programmed. MIFARE or DESFire CSN only, no sector programming.
- N** = Not Programmed (Proximity blank/programmable). MIFARE or DESFire CSN only, no sector programming.
- C** = Custom, Flexpass Proximity programmed. MIFARE or DESFire programmed to customer specification (please call Customer Service for details).
- M** = **(CX Cards Only)** Sequential Matching. Programmed, 125 kHz – **CASI-RUSCO** 12-digit format with matching (6-digit) external marked number. **Note:** inkjet matches last six digits of internal ID number, along with the CX designation and a date code. **CXddy 123456**. A cross reference of marking to encoded number will be provided with the order in .txt (text) format. MIFARE or DESFire non-programmed.
- Q** = **(CX Cards Only)** Sequential Non Matching. Programmed, 125 kHz – **CASI-RUSCO** 12-digit format with a sequential non-matching 6-digit external marked number with a customer specified start number, along with the CX designation and a date code. **CXddy 123456**. A cross reference of marking to encoded number will be provided with the order in .txt (text) format. MIFARE or DESFire non-programmed.

FRONT GRAPHICS

- S** = Standard white glossy finish, suitable for video imaging
- C** = Custom (Artwork on file or new)

BACK GRAPHICS

- S** = Standard white glossy finish with Indala logo, marking (Sales Order Number), suitable for dye sublimation imaging in most areas
- C** = Custom (Artwork on file or new)

MARKING POSITION (Standard Marking or Label Code E153, which is Sales Order and ID number, is used unless otherwise specified) **Note:** Card marking is surface printed and, therefore is not to be considered permanent. In some cases Laser etching will replace inkjet marking. Laser etching is permanent in most applications.

- C** = Position 3/Standard Location (Back Side/Lower Right Corner)

SLOT PUNCH

- N** = None
- V** = Vertical (portrait orientation)

MAGNETIC STRIPE OPTION

- A** = No Magstripe
- B** = Standard Magstripe (3-track, high coercivity, 4000 oersted)

13.56 MHz CONTACTLESS MODULE MEMORY

- A** = 1K memory
- B** = 4K memory

CUSTOM FILE NO. (4 Characters – Factory Assigned)

- 0000** = No Artwork
(Call your Customer Service Representative for new artwork)

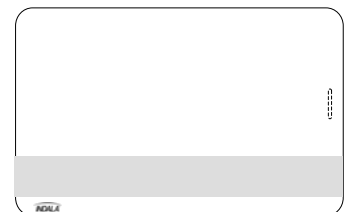

**FlexPass Formats**

The following formats are non-proprietary and are available to all customers. Please call HID to discuss other formats.

Format Name: **26-BIT WIEGAND**

Card Format Number	Facility Code Range	ID Number Range
40134	0 to 255	0 to 65,535 (Systems installed prior to June 2003)
ASP 10022	0 to 255	0 to 65,535 (All new Systems except FP Lite)

Reader Format Numbers

10022 (1L = 1x Wire for LED control)
10200 (2L = 2x Wires for LED control)

Format Name: **27-BIT INDALA**

Card Format Number	Facility Code Range	ID Number Range
4010X	0 to 8,191	0 to 16,383

Reader Format Numbers

10251 (1L = 1x Wire for LED control)
1026X (2L = 2x Wires for LED control)

Format Name: **ABA TRACK 2**

Card Format Numbers	Facility Code Range	ID Number Range
4038X (ASP)	0 to 255	0 to 99,999
17256 (ASP+)	0 to 99,999	0 to 99,999

Reader Format Numbers

11037 OC (Open Collector)
11738 PUR (Pull Up Resistor)

Format Name: **RS232 Serial Data**

Card Format Number	Card Programming Range
16144	up to 24 characters in total length, i.e. ABCD12345678901234567890

Reader Format Number

16144

Format options for FP506B/FP507B Proximity & Keypad Readers (e.g. Format 10022K01)

CFG. Number	Buf/Unbuf	Data Type	Options	Pin Size	Special Keys	Emulates
K01	UnBuffered	8-bit burst			*/# keys enabled	ARK-501
K02	UnBuffered	8-bit burst			*/# keys disabled	
K03	Buffered	Wiegand	facility code xx		*/# keys enabled	
K04	Buffered	Wiegand	facility code xx		*/# keys disabled	
K05	Buffered	Magstripe	LSB First	4 digit PIN	*/# keys enabled	ARK-501 BUFFERED
K06	Buffered	Magstripe	LSB First	4 digit PIN	*/# keys disabled	ARK-501 BUFFERED PINKERTON
K07	Buffered	Magstripe	LSB First	5 digit PIN	*/# keys enabled	
K08	Buffered	Magstripe	LSB First	5 digit PIN	*/# keys disabled	
K09	Buffered	Magstripe	MSB First	4 digit PIN	*/# keys enabled	
K10	Buffered	Magstripe	MSB First	4 digit PIN	*/# keys disabled	
K11	Buffered	Magstripe	MSB First	5 digit PIN	*/# keys enabled	
K12	Buffered	Magstripe	MSB First	5 digit PIN	*/# keys disabled	
K13	Unbuffered	4 bit burst			*/# keys enabled	
K14	Unbuffered	4 bit burst			*/# keys disabled	



Electronic Artwork Requirement Checklist

File Submission & Preparation

This document gives digital artwork specifications from our press department. Use these guidelines and your project should go smoothly through the pre-press department.

MEDIA:

Please submit files via E-Mail or on CD. Compressed files should be self extracting. Submitted media will not be returned to the customer. FTP site available upon request.

PLATFORM: MS WINDOWS®/Macintosh®

Projects that are set up in any of the major applications (listed below under "Graphic Applications") generally translate to Macintosh® smoothly. Please save your final file with pictures embedded, outlined fonts and EPS Vector editable file.

FONTS:

Use Type 1 fonts and include screen and printer fonts on disk. Type may be converted to paths or outlines, but we cannot make copy changes to text submitted in this form. In addition, converted type loses the benefits of PostScript font definitions; hence, type quality may suffer. This is more noticeable in small type (-18 point).

PLACED GRAPHICS:

All placed graphics, saved as TIFF or EPS, should be included in their native program. If a Photoshop image is placed in a Quark document, we need the Photoshop image to produce the job. Sizing, cropping, rotation, etc. should all be done to the element in its native program and placed in Quark. Color images should be converted from RGB to CMYK. Special colors should be designated using PMS or provide color sample to be matched. Resolution of color images, B&W halftones, or duotones should be 300 dpi.

GRAPHIC APPLICATIONS (latest version):

Adobe Photoshop® - Adobe Illustrator® - QuarkXpress®

BITMAPS AND TRACING:

Scanned line art converted to bitmaps should have a resolution of 1200 - 2400 dpi. Lower resolutions will result in jagged curves. Many programs can convert (trace) bitmaps to vector drawings. Smoothing a traced image can be time consuming, but once completed yields a resolution independent graphic that will provide crisp reproduction for all future uses. We can provide this service for you at our regular file intervention rate. Minimum required DPI (dots per inch) is 300.

BLEEDS:

Please incorporate 0.125" of overwork for all bleed images. Any portion of the image that extends to the edge of the product is considered a bleed. Minimum required size with bleed is 2.227" x 3.477" for standard card size file.

MARGINS:

Elements that do not bleed should be at least 0.125" from the edge.



Anti-Counterfeiting Descriptions

Printing Types

- 1) **Laminated Lithographic Printing:** High resolution (>3600 dpi) offset printing technology yields photographic quality images. Laminated printing places the ink layer under a rigid clear plastic overlay which protects the printed image from abrasion and allows you to re-print over the existing artwork on the card. The cards are compatible with all Photo ID printing methods: dye-sub, reverse transfer and resin transfer.
- 2) **Surface Lithographic Printing:** This process is identical to the Laminated Lithographic Printing, but the ink layer is applied to the outer surface of the finished card and may include a clear coat. You may not be able to re-print on the card. The inks and clear coat are not compatible with D2T2 printing (Dye Diffusion Thermal Transfer, AKA dye-sublimation) but may be compatible with reverse transfer printing methods. The surface printing is durable enough for normal handling and use, but may wear more quickly in heavy use or swipe (magnetic stripe) applications. It is not recommended for high use applications, or for printing critical data such as emergency information. This process is often used for quick turnaround of simple text and graphics on card backs.

Surface Hologram

Holograms are one of the most recognizable anti-counterfeiting devices on the market. The optically variable image cannot be duplicated with standard printing. Surface holograms are applied via hot stamping to the exterior of the card surface. This style of application is common to all financial transaction cards.

Embedded Hologram

Embedded holograms are positioned under the rigid clear outer layer of the card surface. Unlike surface holograms, embedded holograms are amenable to dye sublimation – allowing the entire card surface to be personalized. This application style furthers the effectiveness of the anti-counterfeiting feature by requiring expensive specialized equipment during manufacture.

Embedded Advantage™ Security Seal

The Advantage™ product is a specialized optically variable device that is manufactured in only one plant worldwide. It has been the OVD of choice for many government identity documents, including many states driver licenses and the INS card. Like the embedded hologram, this device is placed under the rigid clear outer layer and is not subject to surface abrasion and wear. Advantage™ images shift from orange to green at different viewing angles.

Invisible Ultra-Violet (UV) Fluorescing Images

Common on credit card, currency and travel documents, invisible ink images provide a covert anti-counterfeiting mechanism. Though blue/violet fluorescing ink is readily available and inexpensive, red, green, yellow and orange fluorescing pigments remain difficult to acquire. This covert anti-counterfeiting device remains popular because of its relatively easy implementation in the field.

Microfine Printing

Very small spot color printing that exploits the limitations of inkjet, toner based (laser) and dye sublimation printers. Counterfeit reproductions can be determined with a handheld magnification tool.

Guilloche Printing

Fine line interlocking spot color patterns that are extremely difficult to scan and reproduce. These design elements are often multicolor and are commonly used on currency and travel documents.

Composite Formulations

Composite formulations are designed for durable applications and for use in dye sublimation printers that employ re-transfer technology and/or polyester laminant patches. Composite cards will minimize the warping caused by such processes. These formulations derive their strength from combining biaxially oriented polyester (OPET) with traditional polyvinyl chloride (PVC).



Custom Artwork Placement and Inkjet Location Form

ProxCARD® II Cards

Company Name:		PO No.		Date	
Quantity:		Card and Artwork File No.			

1. External Number:

- Standard Location: The standard external # location is shown on the template below. The external # can only be printed on the back of the card. The external # will be printed in the standard location, unless otherwise specified.
- Custom Location: Please indicate the desired external # location by writing "12345" on the appropriate template. The external # can only be printed on the back of the card.

2. Artwork Placement: Please indicate the placement of your artwork on the template below. Custom artwork must clear the slot punch location and edges by a min. of 0.125"

ProxCARD® II Card Artwork Templates

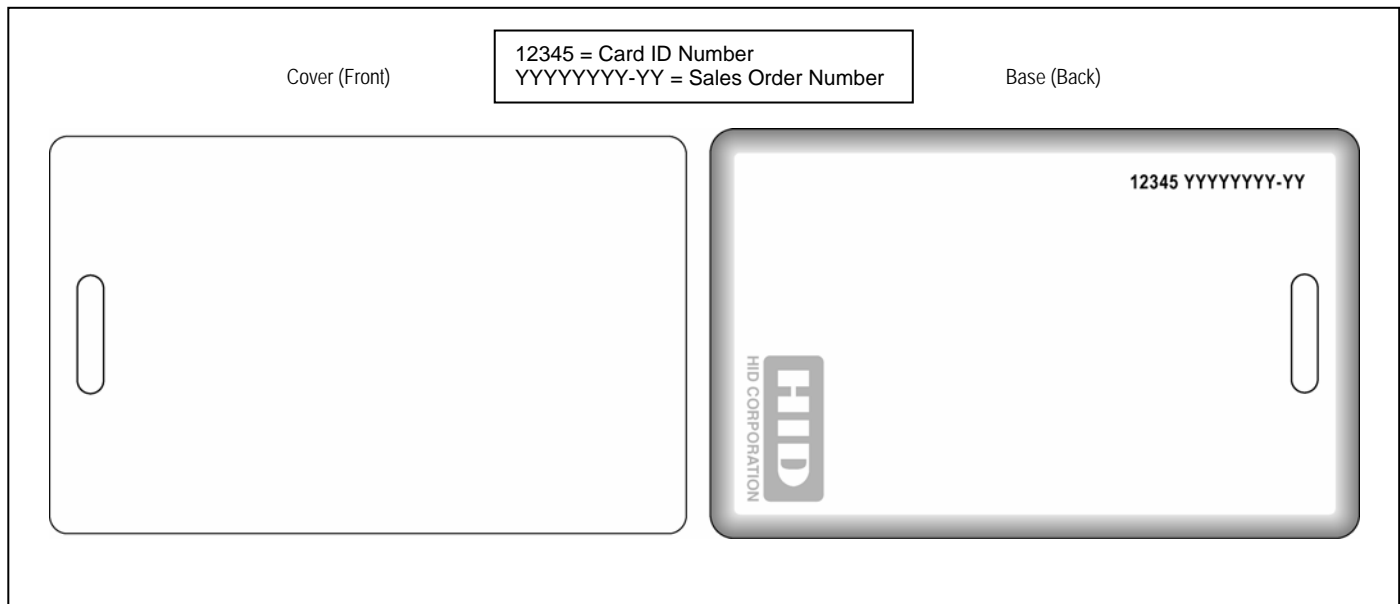

Notes:

- 1. All Prox Card II cards have a molded HID logo on the back side (as indicated) as well as a beveled edge all the way around the card. Custom artwork graphics need to clear the molded logo and bevel by a minimum of 0.125"
- 2. External # location reads in the direction as shown. External # character height is approximately 0.1"
- 3. Please note that there is no custom artwork file number on the Prox Card II.

Name: _____ Signature: _____ Date: _____



DuoProx® II Cards

Company Name:		PO No.		Date	
Quantity:		Card and Artwork File No.			

1. External Number:

Standard Location: The standard external # location is shown on the template below. The external # can only be printed on the back of the card. The external # will be printed in the standard location, unless otherwise specified.

Custom Location: Please indicate the desired external # location by writing "12345" on the appropriate template. The external # can only be printed on the back of the card.

2. An Artwork File Number is placed on each card. The standard location is indicated by the "CCCCC". The standard location for the custom artwork number is on the back side of the card. Please indicate/incorporate the artwork number on the artwork. *If there will be front side printing only, the custom artwork number will be placed on the printed side, opposite the standard location.*

3. Artwork Placement: Please indicate the placement of your artwork on the template below. Custom artwork must clear the slot punch locations, edges and magnetic stripe by a min. of 0.125".

4. Magnetic Stripe: If the location of the magnetic stripe is custom (other than standard) and/or if other types of magnetic stripes are to be added to the card (i.e. Debitek stripe), indicate the location(s) of the magnetic stripe(s) on the template.

Standard Location

Custom Location

DuoProx® II Card Artwork Templates

••••• Slot Punch Indicators

Front

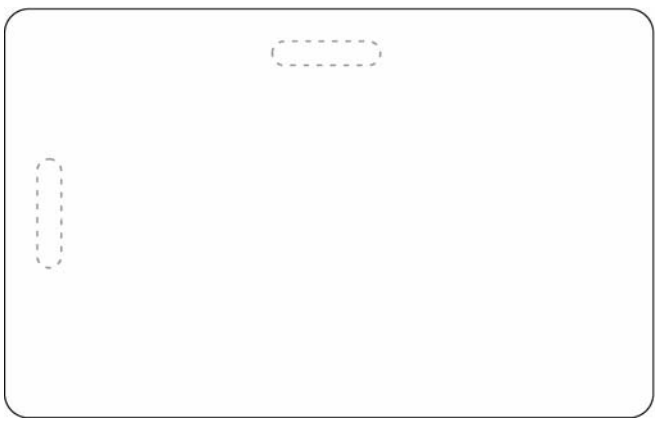

12345 = Card ID Number
 YYYYYYYY-YY = Sales Order Number

Back



Notes:

- External # location reads in the direction as shown. External # character height is approximately 0.1".
- Cards will have a small "HID logo" and reference number printed in the lower left-hand corner and a slot punch target printed on the back of the card.
- A standard custom artwork file number is printed on the back side of the card. Front side printing of this same number is an option.
- Slot punch location "indicators" will appear on the back side of the card only.
- Do not order slot punched cards for use in dye sublimation printers.
Slot edge may damage the printer ribbon. Slot should be punched after dye sublimation printing.
- Some video imaging printers cannot accommodate pre-slot punched cards. Please consult with the printer manufacturer prior to ordering.

Name: _____ Signature: _____ Date: _____



ISOProx® II Cards

Company Name:		PO No.		Date	
Quantity:		Card and Artwork File No.			

1. External Number:

- Standard Location: The standard external # location is shown on the template below. The external # can only be printed on the back of the card. The external # will be printed in the standard location, unless otherwise specified.
- Custom Location: Please indicate the desired external # location by writing "12345" on the appropriate template. The external # can only be printed on the back of the card.

2. An Artwork File Number is placed on each card. The standard location is indicated by the "CCCCC". The standard location for the custom artwork number is on the back side of the card. Please indicate/incorporate the artwork number on the artwork. *If there will be front side printing only, the custom artwork number will be placed on the printed side, opposite the standard location.*

3. Artwork Placement: Please indicate the placement of your artwork on the template below. Custom artwork must clear the slot punch locations and edges by a min. of 0.125".

ISOProx® II Card Artwork Templates

••••• Slot Punch Indicators

Front

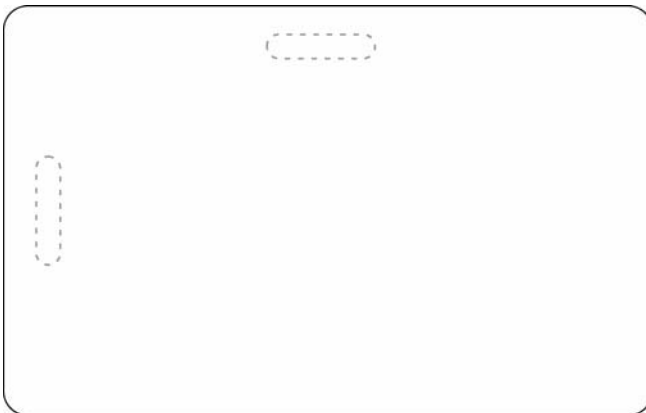

12345 = Card ID Number
YYYYYYYY-YY = Sales Order Number

Back

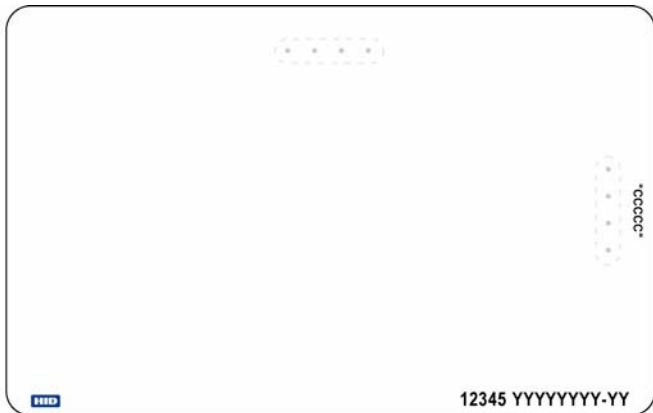

Notes:

1. External # location reads in the direction as shown. External # character height is approximately 0.1".
2. Cards will have a small "HID logo" and reference number printed in the lower left-hand corner and a slot punch target printed on the back of the card.
3. A standard custom artwork file number is printed on the back side of the card. Front side printing of this same number is an option.
4. Slot punch location "indicators" will appear on the back side of the card only.
5. Do not order slot punched cards for use in dye sublimation printers.
Slot edge may damage the printer ribbon. Slot should be punched after dye sublimation printing.
6. Some video imaging printers cannot accommodate pre-slot punched cards. Please consult with the printer manufacturer prior to ordering.

Name: _____ Signature: _____ Date: _____



MicroProx Tag

Company Name:		PO No.		Date	
Quantity:		Tag and Artwork File No.			

1. External Number:

Standard Location: The external # can only be printed on the back of the Tag.

2. Artwork Placement: Please indicate the placement of your artwork on the template below (Front side only). Custom artwork must clear the inner circle by a min. of 0.125".

MicroProx Tag Artwork Template

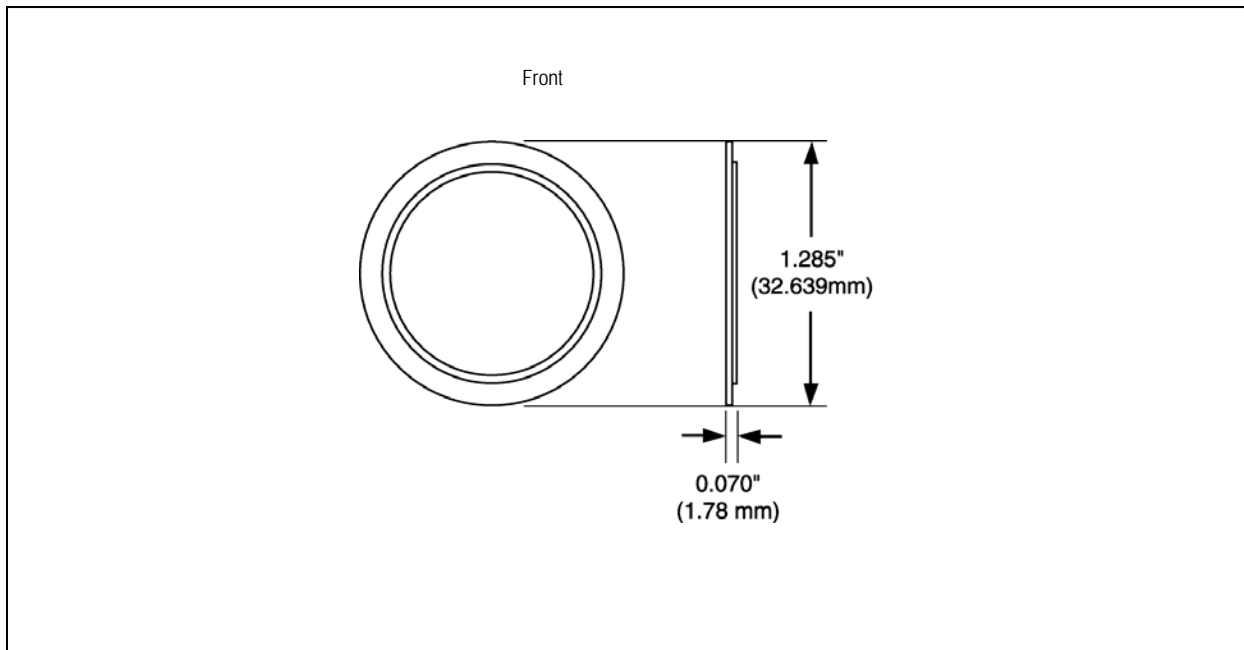

Notes:

- 1. Minimum order quantity 10,000 pieces per Purchase Order.
- 2. Maximum two color artwork.

Name: _____ Signature: _____ Date: _____



1050AGN00 ProxProgrammer® Ordering Guide

Standard Part Number: 1050AGN00

Description: Programmer for HID 125 kHz Programmable RFID Transponders/Cards/ Tags¹, with CD-ROM containing Windows 95/NT compatible software, plug-in power supply, configuration cards, and configurable diskette.

To upgrade⁴ an existing HID ProxProgrammer please provide:

HID Part Number: **1050-306-01**

Serial Number: _____

Software Name: _____
(Software name can be found on the Customer Specific Files Diskette)

Please specify the following^{1,2}:

- A - Format Number # 1 _____
- Facility Code Range, or specific Facility Code _____
- Card Number Range (Start and Stop) _____
- B - Format Number # 2 (If required) _____
- Facility Code Range, or specific Facility Code _____
- Card Number Range (Start and Stop) _____

Customer must also identify the final user of the ProxProgrammer to HID³:

Company Name: _____

Contact Name: _____

Address: _____

Phone #: _____

Fax #: _____

E-mail Address: _____

Entity Type: _____

Incorporation Place: _____

Signatory Authorization: _____

Signatory Title: _____

¹ Only formats authorized for use by your company can be ordered. For HID Format Numbers, please contact HID Customer Service. Consult factory for a list of programmable RFID Transponders/Cards/Tags that can be programmed with this Programmer.

² For Corporate 1000 Format and Custom Facility Code & Card Number Range Programmers, please contact Customer Service for availability, lead times, and pricing.

³ HID requires that a Software License Agreement, signed by the final user of the ProxProgrammer, be on file at HID prior to shipment.

⁴ Software License Agreement does not apply to ProxProgrammer upgrades.



HID Proximity Readers

Accessories

Part No.	Description
ProxPro Family	
5455AGM00	Glass Mount Kit, ProxPro and ProxPro II Readers
5350-113-01	Bezel, ProxPro Reader with Keypad (Rev. A) - Charcoal Gray
5350-113-02	Bezel, ProxPro Reader (Rev. A) - Charcoal Gray
5350-113-03	Bezel, ProxPro Reader with Keypad (Rev. A) - Beige
5350-113-04	Bezel, ProxPro Reader (Rev. A) - Beige
5355A-302-01	Cover, ProxPro w/Keypad Reader (Rev. A) - Charcoal Gray
5355A-302-02	Cover, ProxPro Reader (Rev. A) - Charcoal Gray
5355A-302-03	Cover, ProxPro w/Keypad Reader (Rev. A) - Beige
5355A-302-04	Cover, ProxPro Reader (Rev. A) - Beige
5350-101-01	Base, ProxPro Reader (Rev. A) - Charcoal Gray
5350-101-02	Base, ProxPro Reader (Rev. A) - Beige
5355A-306-01	ProxPro Keypad assembly upgrade, "K" Version, (Rev. A) - Gray Cover only
5355A-306-02	ProxPro Keypad assembly upgrade, "K" Version, (Rev. A) - Beige Cover only
5355A-306-03	ProxPro Keypad assembly upgrade, "S" Version, (Rev. A) - Gray Cover only
5355A-306-04	ProxPro Keypad assembly upgrade, "S" Version, (Rev. A) - Beige Cover only
5355A-306-05	ProxPro Keypad assembly upgrade, "K" Version, (Rev. A) - Gray Cover and Bezel
5355A-306-06	ProxPro Keypad assembly upgrade, "K" Version, (Rev. A) - Beige Cover and Bezel
5355A-306-07	ProxPro Keypad assembly upgrade, "S" Version, (Rev. A) - Gray Cover and Bezel
5355A-306-08	ProxPro Keypad assembly upgrade, "S" Version, (Rev. A) - Beige Cover and Bezel
5455-311-01	Cover, ProxPro II Reader (Rev. B) - Charcoal Gray (No Bezel Required)
5455-311-02	Cover, ProxPro II Reader (Rev. B) - Beige (No Bezel Required)
5455-311-03	Cover, ProxPro II Reader (Rev. B) - Black (No Bezel Required)
5455-311-04	Cover, ProxPro II Reader (Rev. B) - White (No Bezel Required)
30-0003-01	Rubber Keypad Cover, ProxPro Reader (Rev. A)
137-0005-11	Connector Feed Back Nut and Washer, ProxPro Reader (Rev. A)

MiniProx

5365-371-01	Classic cover, MiniProx Reader (Rev. E) - Charcoal Gray
5365-371-02	Classic cover, MiniProx Reader (Rev. E) - Beige
5365-371-03	Classic cover, MiniProx Reader (Rev. E) - Black
5365-371-04	Classic cover, MiniProx Reader (Rev. E) - White
New Look¹	
5365-372-01	Designer cover, MiniProx Reader (Rev. E) - Black
5365-372-02	Designer cover, MiniProx Reader (Rev. E) - Charcoal Gray
5365-372-04	Designer cover, MiniProx Reader (Rev. E) - Wave Blue
5365-372-05	Designer cover, MiniProx Reader (Rev. E) - White

ThinLine II

5395-104-01	Classic cover, ThinLine II Reader (Rev. C) - White
5395-104-02	Classic cover, ThinLine II Reader (Rev. C) - Beige
5395-104-03	Classic cover, ThinLine II Reader (Rev. C) - Black
5395-104-04	Classic cover, ThinLine II Reader (Rev. C) - Charcoal Gray
New Look²	
5395-371-01	Designer cover, ThinLine II Reader (Rev. C) - Black
5395-371-02	Designer cover, ThinLine II Reader (Rev. C) - Charcoal Gray
5395-371-04	Designer cover, ThinLine II Reader (Rev. C) - Wave Blue
5395-371-05	Designer cover, ThinLine II Reader (Rev. C) - White



Part No.	Description
----------	-------------

MaxiProx

5370A-305-01	Cover, MaxiProx Reader (Rev. A) - Gray
5375-303-01	Accessory Kit, MaxiProx Reader (Old wiring Diagram) (Rev. A)
5375-313-01	Accessory Kit, MaxiProx Reader (New wiring Diagram) (Rev. A)
56-0002-01	MaxiProx Reader Rubber Gasket (Rev. A)

ProxPoint Plus

6005-111-01	Classic cover, ProxPoint Plus Reader (Rev. B) - White
6005-111-02	Classic cover, ProxPoint Plus Reader (Rev. B) - Beige
6005-111-03	Classic cover, ProxPoint Plus Reader (Rev. B) - Black
6005-111-04	Classic cover, ProxPoint Plus Reader (Rev. B) - Charcoal Gray
New Look³	
6005-312-01	Designer cover, ProxPoint Plus Reader (Rev. B) - Black
6005-312-02	Designer cover, ProxPoint Plus Reader (Rev. B) - Charcoal Gray
6005-312-04	Designer cover, ProxPoint Plus Reader (Rev. B) - Wave Blue
6005-312-05	Designer cover, ProxPoint Plus Reader (Rev. B) - White

ProxPoint

6005-101-01	Cover, ProxPoint Reader (Rev. A) - White
6005-101-02	Cover, ProxPoint Reader (Rev. A) - Beige
6005-101-03	Cover, ProxPoint Reader (Rev. A) - Black
6005-101-04	Cover, ProxPoint Reader (Rev. A) - Charcoal Gray

Prox80

5405-103-02	Classic cover, Prox80 Reader - Gray
5405-103-05	Classic cover, Prox80 Reader - White

Other

0300-301-1	Prox Readers Demo Kit (ProxPro & MiniProx Readers)
0300-301-2	Wiegand/Prox Readers Demo Kit (MiniProx & Classic Swipe)
4045-390-03	EntryProx Spare Parts Accessories Kit
4045-303-01	EntryProx Reader Replacement Antenna
6020-302-01	Accessory Kit, HSM
33-0001-01	RELAY, 1.00A-24VDC, SPDT-1 FO
33-0001-01	Switch, MultiProx Controller
146-0002-00	Connector, MultiProx Controller
156-XXXX-XX	Firmware Chip - Verify Programming with Technical Support
57-0001-02	Key Ring for ProxKey (Keyfob)
02-0004-01	Universal Power Supply for the ProxProgrammer
1050-306-01	ProxProgrammer Software Upgrade

¹ MiniProx Covers will only fit MiniProx readers with removable covers series (Model # 5365E or later), and will NOT fit older versions with electronics potted into the cover (Model #s 5365A, 5365B, nor 5365C).

² Thinline II Designer Covers will only fit Thinline II readers (Model # 5395C or later), and will NOT fit Thinline II readers (Model #s 5395A nor 5395B).

³ ProxPoint Plus Designer Covers will fit all ProxPoint Plus readers (Model # 6005B or later), and will NOT fit ProxPoint readers (Model # 6005A).

All trademarks and registered trademarks are the properties of their respective companies.



125 kHz How to Order Guide - D00530, B.1

6005 / 6008 - ProxPoint® Plus Proximity Reader Part Numbers and Options

Card Reader Description	Base Part No.	Current Rev. No.*	Color Options	Hardware Options	Configuration Setting Options ¹	Custom ²
ProxPoint Plus Proximity Reader with Wiegand output with Clock and Data output	6005 6008	B B	G = Classic Charcoal Gray B = Classic Beige W = Classic White K = Classic Black 1 = Designer Black 2 = Designer Charcoal Gray 4 = Designer Wave Blue 5 = Designer White	B = Pigtail (18 inches/45.7 cm) L = Long Pigtail (9 feet/3 meters) ³	00 04 01 05 02 06 03 07	XXXX Y

*Revision numbers and availability are subject to change without notice.

Notes:

¹ Configuration Setting Options are as follows (factory programmed):

- 00 = Beep on, LED normally red, reader flashes green on tag read
- 01 = Beep off, LED normally red, reader flashes green on tag read
- 02 = Beep on, LED normally off, reader flashes green on tag read
- 03 = Beep off, LED normally off, reader flashes green on tag read

- 04 = Beep on, LED normally red, host must flash green
- 05 = Beep off, LED normally red, host must flash green
- 06 = Beep on, LED normally off, host must flash red and/or green
- 07 = Beep off, LED normally off, host must flash red and/or green

² Consult Factory

³ An optional 9 foot pigtail is available through our HID European office and can also be available in the Americas and Asia Pacific regions via special order of 2,500 unit minimum order quantity. Please call the HID factory for pricing and lead-times.

To order, please specify the following:

Card Reader Description	Base Part No.	Current Rev. No.*	Color Options	Hardware Options	Configuration Setting Options	Custom



5365 / 5368 - MiniProx® Proximity Reader Part Numbers and Options

Card Reader Description	Base Part No.	Current Rev. No.*	Color Options	Hardware Options	Configuration Setting Options ¹	Custom ²
MiniProx Proximity Reader with Wiegand output with Clock and Data output	5365 5368	E E	G = Classic Charcoal Gray B = Classic Beige W = Classic White K = Classic Black 1 = Designer Black 2 = Designer Charcoal Gray 4 = Designer Wave Blue 5 = Designer White	P = Pigtail (18 inches/45.7 cm) T = Terminal Strip H = Hazardous back box ³ L = Long Pigtail (9 feet/3 meters) ⁴	00 04 01 05 02 06 03 07	XXXX Y

*Revision numbers and availability are subject to change without notice.

Notes:

¹ Configuration Setting Options are as follows (factory programmed):

- 00 = Beep on, LED normally red, reader flashes green on tag read
- 01 = Beep off, LED normally red, reader flashes green on tag read
- 02 = Beep on, LED normally off, reader flashes green on tag read
- 03 = Beep off, LED normally off, reader flashes green on tag read

- 04 = Beep on, LED normally red, host must flash green
- 05 = Beep off, LED normally red, host must flash green
- 06 = Beep on, LED normally off, host must flash red and/or green
- 07 = Beep off, LED normally off, host must flash red and/or green

² Consult Factory

³ The hazardous back box option MiniProx is available in gray Terminal Strip only.

⁴ An optional 9 foot pigtail is available through our HID European office and can also be available in the Americas and Asia Pacific regions via special order of 2,500 unit minimum order quantity. Please call the HID factory for pricing and lead-times.

To order, please specify the following:

Card Reader Description	Base Part No.	Current Rev. No.*	Color Options	Hardware Options	Configuration Setting Options	Custom



5455 / 5458 / 5355 / 5352 /5358 - ProxPro® Family Proximity Reader Part Numbers and Options

ProxPro® II Card Reader Description	Base Part No.	Current Rev. No.*	Color Options	Hardware Options	Configuration Setting Options ¹	Custom ²
ProxPro® II Proximity Reader with Wiegand output with Clock & Data Output	5455 5458	B	G = Charcoal Gray B = Beige W = White K = Black	N = No Keypad, Pigtail (18 inches/45.7 cm) L = No Keypad, Long Pigtail (9 feet/3 meters) ⁸	00 04 01 05 02 06 03 07	XXXX Y

ProxPro® Card Reader Description	Base Part No.	Current Rev. No.*	Color Options	Hardware Options	Configuration Setting Options ^{5,7}	Custom ²
ProxPro® Proximity Reader with Wiegand output with Serial output ⁶ with Clock & Data Output	5355 5352 5358	A	G = Charcoal Gray B = Beige	N = No Keypad, Terminal Strip K = Keypad ³ , Terminal Strip S = Keypad ⁴ , Terminal Strip	00 09 10 11 14 19 20 21	XXXX Y

*Revision numbers and availability are subject to change without notice.

¹ ProxPro II Configuration Setting Options are as follows (factory programmed):

- 00 = Beep on, LED normally red, reader flashes green on tag read
- 01 = Beep off, LED normally red, reader flashes green on tag read
- 02 = Beep on, LED normally off, reader flashes green on tag read
- 03 = Beep off, LED normally off, reader flashes green on tag read

- 04 = Beep on, LED normally red, host must flash green
- 05 = Beep off, LED normally red, host must flash green
- 06 = Beep on, LED normally off, host must flash red and/or green
- 07 = Beep off, LED normally off, host must flash red and/or green

² Consult Factory.

³ ProxPro Reader with Keypad (Hardware Option "K" Version): data is outputted over shared Wiegand cable. Reader processes keystrokes.

⁴ ProxPro Reader with Keypad (Hardware Option "S" Version): (3 x 4 Matrix) requires additional 7 conductor keypad cable. Control panel processes keystrokes.

⁵ ProxPro Configuration Setting options are as follows (factory programmed):

- 00 = Buffer one key, no parity, 4 bit message
- 09 = Buffer one key, add compliment, 8 bit message (Dorado)
- 10 = Buffer six keys and add parity
- 11 = Buffer one key and add parity

- 14 = Buffer one to five keys (Standard 26 bit output)
- 19 = Buffer four keys and add parity
- 20 = Single Key buffering
- 21 = Supervision Mode

⁶ ProxPro Serial output reads cards with up to 37-bit formats, and outputs RS232, RS422, and RS485.

⁷ ProxPro reader Configuration Settings are selected by the customer via dip switch settings. 00 = LED normally red, reader flashes green on tag reads.

⁸ An optional 9 foot pigtail is available through our HID European office and can also be available in the Americas and Asia Pacific regions via special order of 2,500 unit minimum order quantity. Please call the HID factory for pricing and lead-times.

Optional Glass Mount Kit for ProxPro and ProxPro II Readers = 5455AGM00.

To order, please specify the following:

Card Reader Description	Base Part No.	Current Rev. No.*	Color Options	Hardware Options	Configuration Setting Options	Custom



5395 / 5398 - ThinLine® II Proximity Reader Part Numbers and Options

Card Reader Description	Base Part No.	Current Rev. No.*	Color Options	Hardware Options	Configuration Setting Options ¹	Custom ²
ThinLine II Proximity Reader with Wiegand output with Clock and Data output	5395 5398	C	G = Classic Charcoal Gray B = Classic Beige W = Classic White K = Classic Black 1 = Designer Black 2 = Designer Charcoal Gray 4 = Designer Wave Blue 5 = Designer White	1 = Pigtail (18 inches/45.7 cm) L = Long Pigtail (9 feet/3 meters) ³	00 04 01 05 02 06 03 07	XXXX Y

*Revision numbers and availability are subject to change without notice.

Notes:

¹ Configuration Setting Options are as follows (factory programmed):

- 00 = Beep on, LED normally red, reader flashes green on tag read
- 01 = Beep off, LED normally red, reader flashes green on tag read
- 02 = Beep on, LED normally off, reader flashes green on tag read
- 03 = Beep off, LED normally off, reader flashes green on tag read

- 04 = Beep on, LED normally red, host must flash green
- 05 = Beep off, LED normally red, host must flash green
- 06 = Beep on, LED normally off, host must flash red and/or green
- 07 = Beep off, LED normally off, host must flash red and/or green

² Consult Factory

³ An optional 9 foot pigtail is available through our HID European office and can also be available in the Americas and Asia Pacific regions via special order of 2,500 unit minimum order quantity. Please call the HID factory for pricing and lead-times.

To order, please specify the following:

Card Reader Description	Base Part No.	Current Rev. No.*	Color Options	Hardware Options	Configuration Setting Options	Custom



5375 - MaxiProx® Proximity Reader Part Numbers and Options

Card Reader Description	Base Part No.	Current Rev. No.*	Color Options	Hardware Options	Configuration Setting Options ¹	Custom ²
MaxiProx® Proximity Reader	5375	A	G = Charcoal Gray	N = None	00	XXXX Y

*Revision numbers and availability are subject to change without notice.

Notes:

¹ Configuration Setting 00 = LED normally red, reader flashes green on tag reads.

The MaxiProx® reader configuration settings are selected by the customer via internal dip switch settings.

² Consult Factory

To order, please specify the following:

Card Reader Description	Base Part No.	Current Rev. No.*	Color Options	Hardware Options	Configuration Setting Options	Custom



5385 / 6000 / 6020 - MultiProx® Proximity Family Part Numbers and Options

Card Reader Description	Base Part No.	Current Rev. No.*	Color Options	Hardware Options	Configuration Setting Options ¹	Custom ²
MultiProx Proximity Reader	5385	A	G = Charcoal Gray	S = Side Connector B = Back Connector	00	XXXX Y
MultiProx Controller with 24 volt, coaxial - to Wiegand Interface	6000	B	N = None	N = None	00	XXXX Y
MultiProx HSM Interface	6020	A	N = None	N = None	00	XXXX Y

*Revision numbers and availability are subject to change without notice.

Notes:

¹ Configuration Setting 00 = LED normally red, reader flashes green on tag reads.

² Consult Factory

To order, please specify the following:

Card Reader Description	Base Part No.	Current Rev. No.*	Color Options	Hardware Options	Configuration Setting Options	Custom



4045 - EntryProx™ Proximity Reader Part Numbers and Options

Card Reader Description	Base Part No.	Current Rev. No.*	Color Options	Hardware Options	Configuration Setting Options ¹	Custom ²
EntryProx™ Proximity Reader Stand-Alone Access Control Unit	4045	C	G = Charcoal Gray	N = None	U0	XXXX Y
EntryProx™ Proximity Reader Stand-Alone Access Control Unit	4045	C	G = Charcoal Gray	K = Key Kit (Includes 10 ProxKey® II Tags) ³	U0	XXXX Y
EntryProx™ Proximity Reader Stand-Alone Access Control Unit	4045	C	G = Charcoal Gray	C = Card Kit (Includes 20 ProxCard® II Cards) ³	U0	XXXX Y

*Revision numbers and availability are subject to change without notice.

Notes:

¹ Configuration Setting U0 = LED normally red, reader flashes green on tag reads.

² Consult Factory

³ Proximity cards and keytags included in kits will be programmed with HID's 37-bit Wiegand format (H10302).

HID tracks the issuance of this format and does not duplicate numbers. Numbers will be issued in random order.

⁴ Infrared Printer and Printer Paper can be used with previously purchased 4045B EntryProx Models, which are no longer available.

To order, please specify the following:

Card Reader Description	Base Part No.	Current Rev. No.*	Color Options	Hardware Options	Configuration Setting Options	Custom



5405 / 5408 - Prox80™ Proximity Reader Part Numbers and Options

Card Reader Description	Base Part No.	Current Rev. No.*	Color Options	Hardware Options	Configuration Setting Options ²	Custom ³
Prox80™ Proximity Reader ¹ with Wiegand output with Clock and Data output	5405 5408	A	W = White G = Gray	L = Long Pigtail (9 feet/3 meters)	00 04 01 05 02 06 03 07	XXXX Y

*Revision numbers and availability are subject to change without notice.

Notes:

¹ Available through our HID European office and can also be available in the Americas and Asia Pacific regions via special order of 2,500 unit minimum order quantity. Please call the HID factory for pricing and lead-times.

² Configuration Setting Options are as follows (factory programmed):

- 00 = Beep on, LED normally red, reader flashes green on tag read
- 01 = Beep off, LED normally red, reader flashes green on tag read
- 02 = Beep on, LED normally off, reader flashes green on tag read
- 03 = Beep off, LED normally off, reader flashes green on tag read

- 04 = Beep on, LED normally red, host must flash green
- 05 = Beep off, LED normally red, host must flash green
- 06 = Beep on, LED normally off, host must flash red and/or green
- 07 = Beep off, LED normally off, host must flash red and/or green

³ Consult Factory

To order, please specify the following:

Card Reader Description	Base Part No.	Current Rev. No.*	Color Options	Hardware Options	Configuration Setting Options	Custom



Indala Proximity Readers

Overview

Every part number consists of a base model number to indicate the type of product, and a letter or number to indicate each product option. Each product has a standard part number that includes default options, as indicated on the order guide. When an order is placed for a product, the base model number and all options must be specified. If you require any options that are different from the default options, you must also indicate those options at the time the order is placed. All part numbers must be complete to be accepted by HID's order entry system.

All reader orders must have the following information:

- **BASE MODEL NUMBER**
- **STYLE**
- **READ RANGE**
- **TYPE**
- **COLOR**
- **OUTPUT FORMAT** (*reader's format or format number must also be given at time of order*)



FP - FlexPass® Reader Ordering Guide

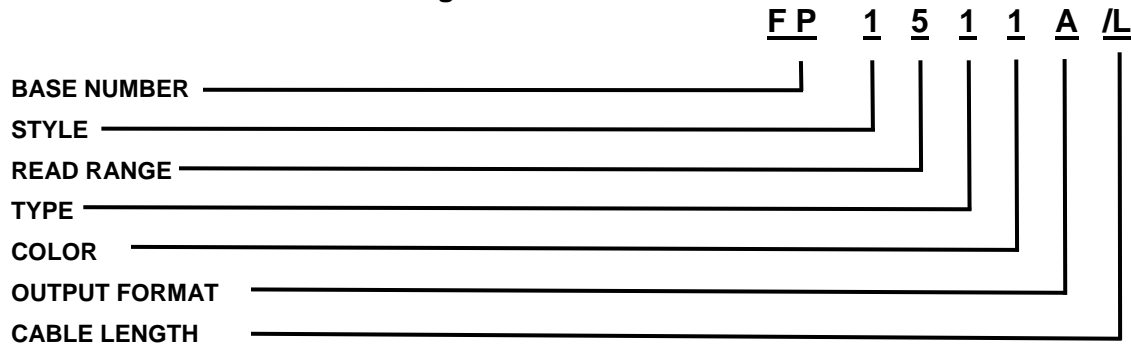

BASE NUMBER

FP = FlexPass (reader format required)

STYLE

- 1 = Wave
- 2 = Curve
- 3 = Arch
- 4 = Linear
- 5 = Keypad
- 0 = Core Electronics Module

READ RANGE

- 5 = 5 in. (13 cm.) – available in STYLES: Wave, Curve, Arch, Linear TYPES: Slim and Wall switch
- 2 = 12 in. (30 cm.) – available in STYLES: Wave, Arch TYPE: Midrange
- 0 = 4 in. (10 cm.) – available only in STYLE: Keypad; TYPE: Keypad

TYPE

- 1 = Slim – available in STYLES: Wave, Curve, Arch, Linear
- 2 = Wall switch – available in STYLES: Wave, Curve, Arch, Linear, MIFARE®
- 3 = Midrange – available in STYLES: Wave, Arch
- 5 = Classic (previously known as Mag-Stripe) – available STYLE: Linear
- 6 = Membrane Keypad – available only in STYLE: Keypad
- 7 = Heavy Duty Keypad – available only in STYLE: Keypad
- 0 = Module only

COLOR

- 1 = Black – available in STYLES: Wave, Curve, Arch, Linear TYPES: Slim, Wall switch, Midrange, Classic
- 4 = Blue – available in STYLES: Wave TYPES: Slim, Wall switch, Midrange
- 5 = Grey – available in STYLES: Arch TYPES: Slim, Wall switch, Midrange
- 6 = White – available in STYLES: Arch TYPES: Slim, Wall switch, Midrange
- 7 = Beige – available in STYLES: Arch, Keypad TYPES: all
- 0 = N/A

OUTPUT FORMAT

(Aside from choosing below, please specify reader's format or format no. – e.g. 26-bit Wiegand or format no. 10022)

- A** = Standard Wiegand – available in all STYLES and TYPES
- S** = Serial – available in STYLES: Wave, Curve, Arch TYPE: Midrange
- B** = Buffered or 8-Bit Burst (must be specified) - available only in Keypad STYLE and TYPE (Membrane or Heavy Duty)
- M** = 3 X 4 Matrix

CABLE LENGTH

(The standard cable length for Indala modules is 18 inches (46 cm). No entry needed for 18 in cable. To order a core module with a 10 foot (3 meter) cable, "L" is placed in position VII. READER PACKAGES CANNOT BE ORDERED WITH THE LONG (10 Ft, 3 Meter) cable. However, Reader Core Modules with the long cable can be ordered. Bezels must then be ordered separately. Please call Customer Service for assistance.



Advantage Series (ASR) Reader Ordering Guide

Part Number	Description	Notes
ASR-620++	Long Range Reader	
ASR-505-NGR-BGE	Legacy Wall Switch Beige	(Not compatible with ASP+ formats)
ASR-620++/L	Long Range Reader	w/10 foot (3 meter) cable
ASR-503-NGR	Legacy Mullion Black	(Not compatible with ASP+ formats)
ASR-503-NGR/L	Legacy Mullion Black w/10 foot (3 meter) cable	(Not compatible with ASP+ formats)
ASR-505-NGR-BLK	Legacy Wall switch Black	(Not compatible with ASP+ formats)
ASR-505-NGR-BLK/L	Legacy Wall switch Black w/10 foot (3 meter) cable	(Not compatible with ASP+ formats)
ASR-505-NGR-BGE	Legacy Wall switch Beige	(Not compatible with ASP+ formats)
ASR-505-NGR-BGE/L	Legacy Wall switch Beige w/10 foot (3 meter) cable	(Not compatible with ASP+ formats)

ProxSmith Programmer and Software Part Numbers

Part Number	Description
AFP-1000	ProxSmith Programmer and software comes with 26 bit Wiegand and ABA TrackII compliant formats loaded.

**FlexPass Accessories**

Part Number	Description
21211-001	Enclosure Base, ASR-620
21212-001	Enclosure Cover, ASR-620++
BIL-422-232	RS232/432 Protocol Adaptor
FPZ1231A	Bezel Wave Style, Midrange Type, Black
FPZ1234A	Bezel Wave Style, Midrange Type, Blue
FPZ1511A	Bezel Wave Style, Slim Type, Black
FPZ1514A	Bezel Wave Style, Slim Type, Blue
FPZ1521A	Bezel Wave Style, Wallswitch Type, Black
FPZ1524A	Bezel Wave Style, Wallswitch Type, Blue
FPZ2511A	Bezel Curve Style, Slim Type, Black
FPZ2521A	Bezel Curve Style, Wallswitch Type, Black
FPZ3231A	Bezel Arch Style, Midrange Type, Black
FPZ3235A	Bezel Arch Style, Midrange Type, Grey
FPZ3236A	Bezel Arch Style, Midrange Type, White
FPZ3237A	Bezel Arch Style, Midrange Type, Beige
FPZ3511A	Bezel Arch Style, Slim Type, Black
FPZ3515A	Bezel Arch Style, Slim Type, Grey
FPZ3516A	Bezel Arch Style, Slim Type, White
FPZ3517A	Bezel Arch Style, Slim Type, Beige
FPZ3521A	Bezel Arch Style, Wallswitch Type, Black
FPZ3521H	Bezel Arch Style, Wallswitch Type, Black (HID)
FPZ3525A	Bezel Arch Style, Wallswitch Type, Grey
FPZ3526A	Bezel Arch Style, Wallswitch Type, White
FPZ3527A	Bezel Arch Style, Wallswitch Type, Beige
FPZ3527H	Bezel Arch Style, Wallswitch Type, Beige (HID)
FPZ4511A	Bezel Linear Style, Slim Type, Black
FPZ-4511A	Bezel Linear Slim Black Cover
FPZ4517A	Bezel Linear Style, Slim Type, Beige
FPZ4521A	Bezel Linear Style, Wallswitch Type, Black
FPZ4525A	Bezel Linear Style, Wallswitch Type, Grey
FPZ4526A	Bezel Linear Style, Wallswitch Type, White
FPZ4527A	Bezel Linear Style, Wallswitch Type, Beige
FPZ4551A	Bezel Linear Style, Slim Type, Black
FPZC1511A	Bezel, Blank, Wave, Slim, 5", Black
FPZC1511H	Bezel, HID, Wave, Slim, 5", Black
FPZC1514A	Bezel, Blank, Wave, Slim, 5", Blue
FPZC1514H	Bezel, HID, Wave, Slim, 5", Blue
FPZC1521A	Bezel, Blank, Wave, Wallswitch, 5", Black
FPZC1524H	Bezel, HID, Wave, Wallswitch, 5", Blue
KIT-AFP1000-2005	AFP1000-2005, Upgrade
KIT-AFP1000-2005-A/R	AFP1000 Advance Replacement
XXZ112	Bezel, Wave, Slim, 5", Blue
XXZ122	Bezel, Wave, W/S, 5", Blue
XXZ321	Bezel, Arch, W/S, Black
SH-003	Indala Credentials Special Handling, New marking label codes

¹ To ensure security of the format and cards, a Software License Agreement must be signed by the final user of the 3175BNN00, 3012AKN00, 3012ANS00, and be on file at HID prior to shipment.

² Developer's Resource CD includes: Serial Protocol Documentation and Developer's Test Program to assist in developing custom MIFARE software applications.

³ Demo CD Includes: MIFARE Documentation and Sample Application Program.



Corporate 1000™ Format - Request & Authorization Form

Corporate 1000 is a 35-bit card format that is developed specifically for use by individual end-user organizations. Organizations must qualify, formally enroll and be accepted by HID Global Corporation.

The Corporate 1000 Format is offered to large, multi-location, and end-user organizations which use HID access control readers and cards. In this program, the end-user has the flexibility to choose any access control hardware/software platform and any HID System Provider. As the end-user utilizing the Corporate 1000 Program, fill in your company information in **TABLE I**. Ensure all fields are complete for the primary and secondary (if desired) authorized contacts within your company.

TABLE I: Your Company's Primary and Secondary Contacts

Information	Primary Company Contact	Secondary Company Contact
Company Name		
Mailing Address		
City		
State/Province		
Country		
Zip/Postal Code		
Contact Name		
Title		
Contact Signature	X	X
Phone Number		
Fax Number		
E-mail Address		

Card numbers available within the Corporate 1000 format are 0 – 1,048,575.

Indicate the card number in which your first order should start: Enter start number here.

All card numbers following this number will be "blocked" from use. If you do not specify a card start number, your first order will start at one (1). Should you require assistance, contact your systems provider or HID directly.

Added card security:

- Invisible Ink
 Advantage® OVD
 Hologram
 Micro-fine Printing
 Signature Panel

Once accepted into the Corporate 1000 Program, HID shall grant a royalty free license to use the Corporate 1000 Format within your organization. Please sign below to enroll in this program and to confirm your acceptance of the License Agreement.

ACCEPTANCE OF HID CREDENTIAL PROGRAM LICENSE AGREEMENT	
The undersigned party hereby accepts and agrees to be bound by the terms and conditions of the HID Credential Program. License Agreement is located at www.hidglobal.com/pdfs/credential_license.pdf , pursuant to which a license is granted to the undersigned party authorizing the use of certain credential formats in connection with participation by the undersigned in the HID Corporate 1000 Program.	
Dated: _____	Authorized Signature : X _____
Company Name : _____	Contact Name: _____
	Title : _____



To ensure the security of your card format, authorize any HID System Provider to purchase and manage your Corporate 1000 cards on your behalf. Enter authorized HID System Provider information in Table II, and HID System Installers in Table III.

Use this form to communicate all authorization concerning your Corporate 1000 format. It is recommended for each end-user to maintain an original copy of this form listing all authorizations.

TABLE II: Authorized HID System Providers

	Company # 1	Company # 2
Company Name		
Contact Name		
Title		
Address		
Phone Number		
Fax Number		
E-Mail Address		
Authorized End-User Name		
Authorized End-User Signature	X	X
Date		

TABLE III: Authorized HID System Installers

	Company # 1	Company # 2
Company Name		
Contact Name		
Title		
Address		
Phone Number		
Fax Number		
E-Mail Address		
Authorized End-User Name		
Authorized End-User Signature	X	X
Date		

Send to HID Global for approval and processing: Fax: (949) 598-5756.

For assistance, contact your Customer Service Representative. To add or remove authorizations, submit an HID Global Corporate 1000 Change Form.

For Internal Use Only:

HID Sales Manager:	X	
	Print Name	Signature
		Date
Issued Corporate 1000 Format No.:		Entered by HID Global after approval.



Index of Terms for HID Credentials

Card	An HID Card is a credit card size piece of plastic that contains electronic circuitry that works with HID readers. The term "Card" is often loosely applied to Keyfobs and Tags as well.
Keyfob	A plastic device, roughly the size of a car key, that works like a Card. It is more rugged than a card and very convenient to carry on a key ring. It has a shorter "Read Range" (distance from the reader) than a true card because it is smaller.
Tag	Tags work like Cards, but are made in a circular shape, a little larger than a quarter. They have an adhesive back and can be adhered to any non-metallic surface to allow some other device to work like an HID Card. Like the Keyfob, Tags have a shorter read range. (NOTE: The Model 1351 Vehicle ID Tag is a special case. It is a battery powered Prox device, larger and thicker than a card, that is used only for identifying cars, trucks, etc. in parking applications.)
Model	Every HID credential has a unique " Base Part Number ". This number is used when ordering Cards, Keyfobs or Tags to identify exactly what you want to buy.
Options	Each Model has a unique set of available options selected from the following choices. For example, a Tag is not available with a slot punch; however, you still must enter an "N" in the order form.
Programming	Every HID Card, Keyfob or Tag must have specific data programmed into it before it can be used. Most customers have HID do the programming and order their cards that way. A few customers have their own programmers and order non-programmed cards.
Front / Back Packaging	Packaging is a term that defines the appearance of the Front and Back of every credential. Options include color, glossy finish, custom artwork, etc. Front and Back Packaging are defined individually.
Credential Numbering	There are two distinct "Numbers" that apply to each credential. Every programmed Card, Keyfob, Tag will have a number inside it that will be read by the HID reader when the card is used. This is the "Internal Number. It is how an Access Control Unit recognizes the Credential. It is also possible for cards to have a number printed on the outside surface . This number is for use by people who manage the entry of cardholder data into an Access Control System. It can be the same as, or different from the internal number.
Slot Punch	Some cards can have a slot punched in the edge to allow them to hang either horizontally or vertically. ProxCard II (1326) has a built-in slot.
Custom Artwork	Some customers pay HID to print their cards with personalized artwork. This may include a company Logo, a return address (for lost cards), or a special artistic color scheme. The card front, back, or both sides can be printed. The customer must provide the exact artwork they want to HID. We will issue a unique number for that customer to identify their artwork.